

Model Number:
FLS-24V-2835-CCTX484

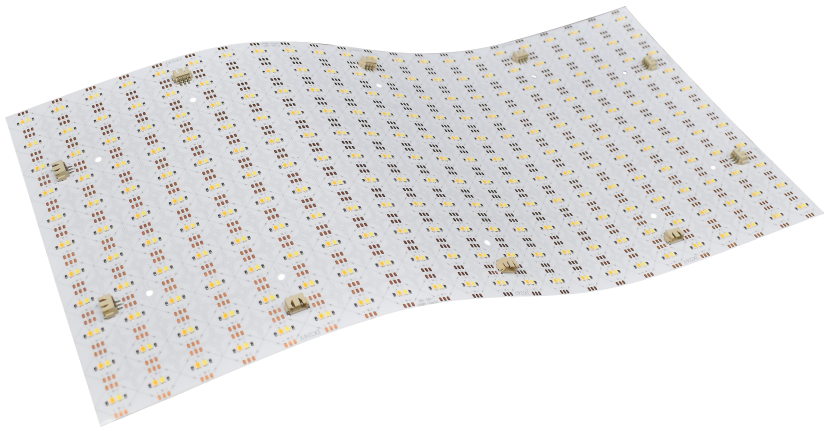

SuperlightingLED is committed to provide high quality LED lighting product and superior service for market.

1. The LED are packaged with pure gold wires and large-size chips.
2. Only one Bin LED is used for each order, and keep the same Bin LED in subsequent orders to ensure the consistency of the product.
3. The production process adopts high-temperature, lead-free SMT technology, the solder joints are smooth and full.
4. Use double-layer PCB to ensure stable electrical performance.
5. Use original authentic 3M tape, strong and long-lasting adhesion.
6. A variety of installation accessories are optional, flexible and convenient to use.
7. Different IP grade are available: IP20, IP54.
8. High light transmittance, environment friendly silicone material is used for waterproof product, colorless, odorless and anti-yellowing.

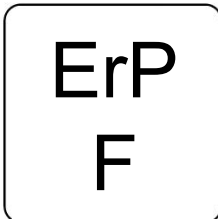
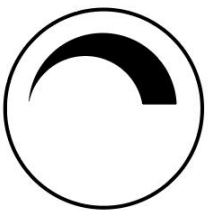

IP20		IP54	
CRI 80	CRI 90	CRI 95	CRI 97

Product description

1. Dimensions: 490*245mm
2. Power: 40W/PCS
3. LED type:
Lumileds SMD2835, high brightness LED
4. LED quantity: 484LEDs/PCS
5. LED color: 2700+6500K
6. Cut length:
DC12/24V 2LEDs/ 22.3*22.3mm
7. PCB material: double layer FPC
8. Life time: 36000hours
9. IP grade: IP20, IP54

Application

- Home decoration lighting
- Light box lighting stage lighting
- Decoration of entertainment places
- Other auxiliary lighting

Product picture

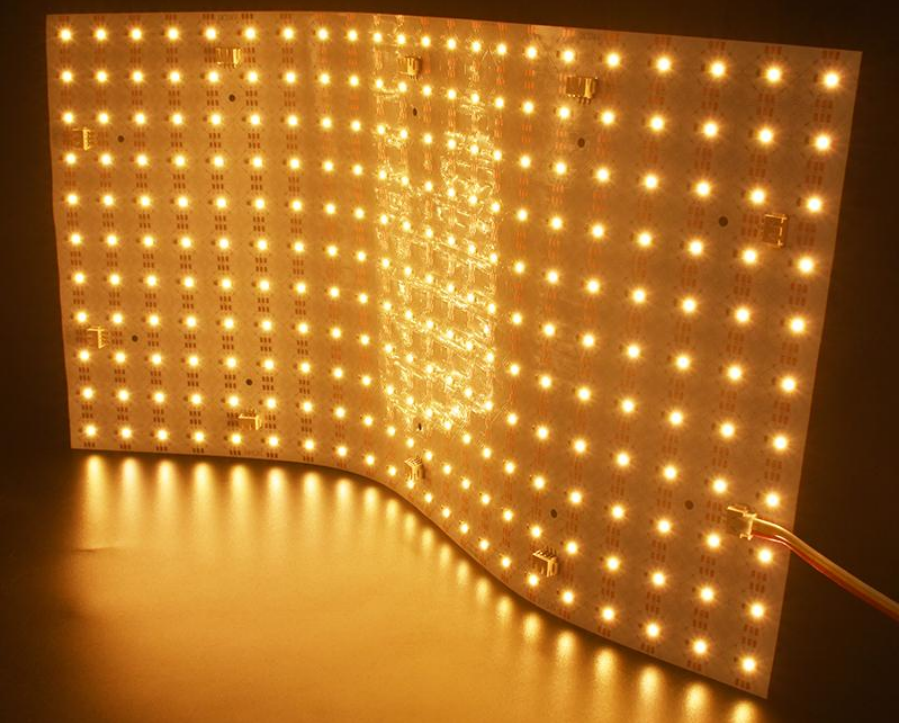
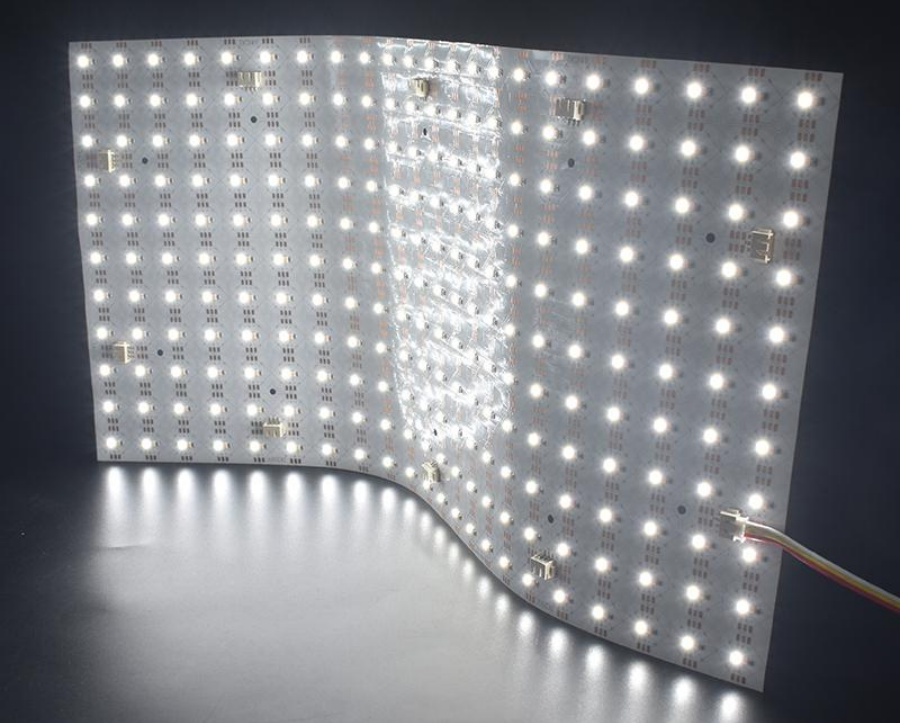

Application scenarios

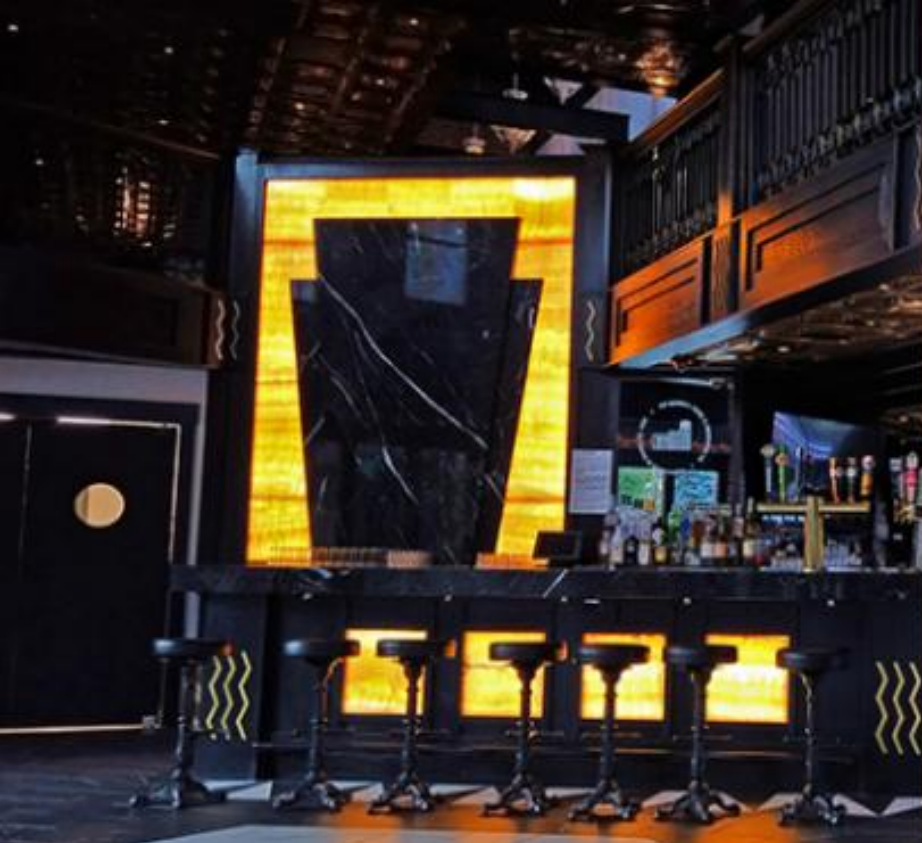

Technical parameters

Optical parameters(white)	Electrical performance parameters	Other parameters
Luminous: 3800Lm/m CCT: 2700+6500K CRI: Ra>80 Beam angle: 120° Light efficiency: 95Lm/W	Voltage: DC12/24V Current:3.33A/ 1.66A Power: 40W/PCS	Storage temperature: -20~+60°C Working temperature: -20~+60°C Life time: >36000 hours Warranty: 3 years

Dimensions

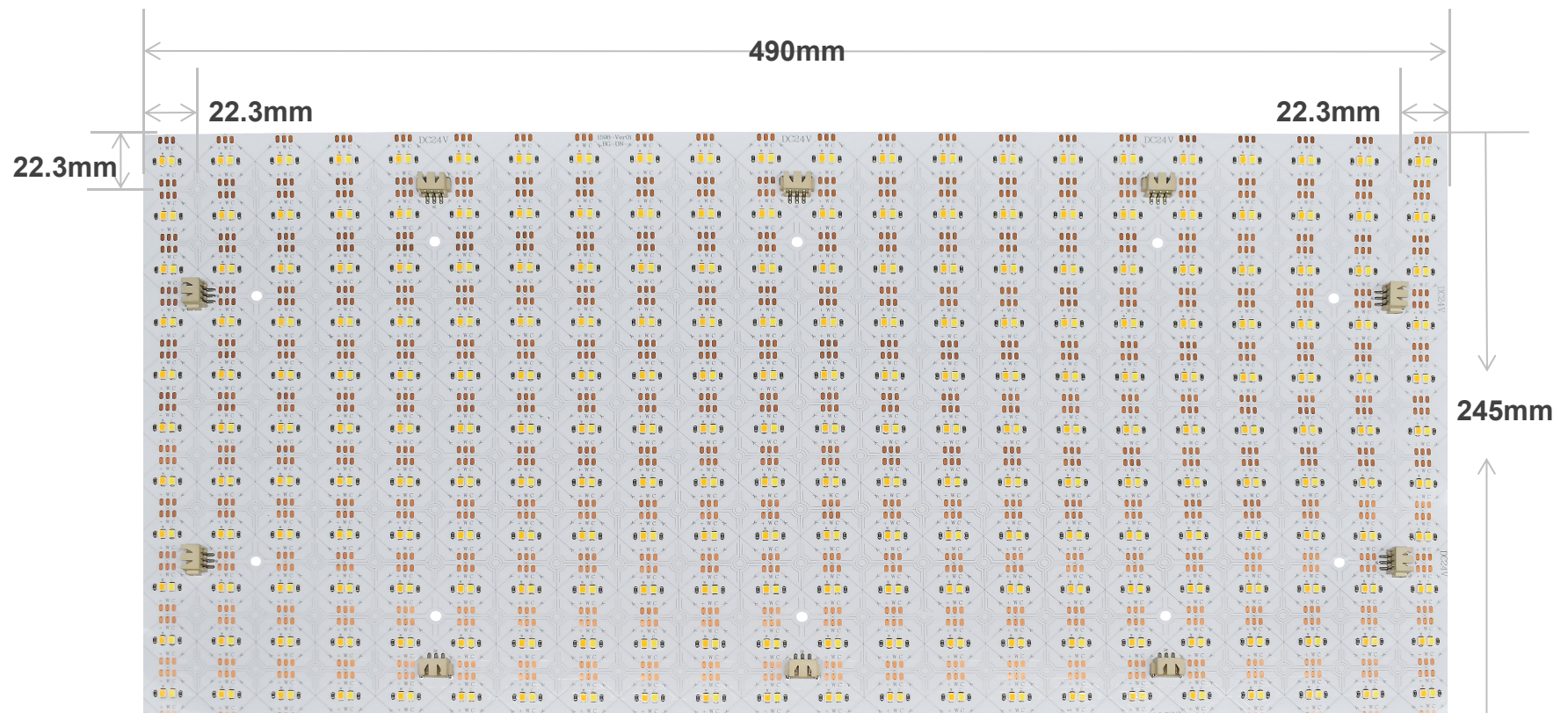

Color standard

<2200K

2700K

3000K

4000K

6000K

>8000K

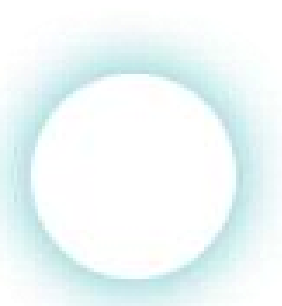
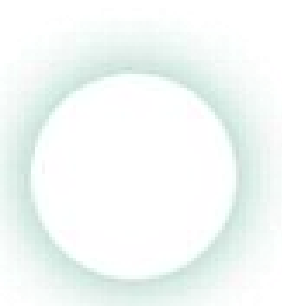
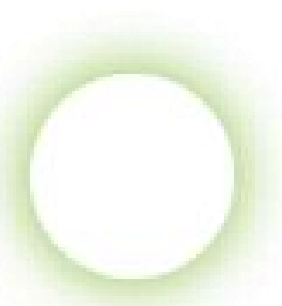
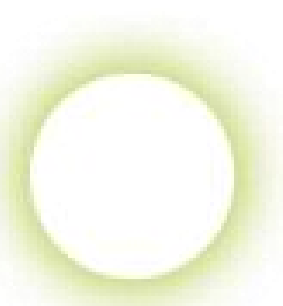
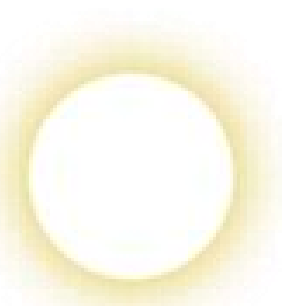
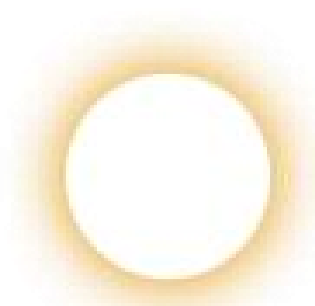

Super Warm
White

Warm White

Warm White
Halogen
Incandessent

Natural White
Metal Holide

White

Cold White

Connection diagram

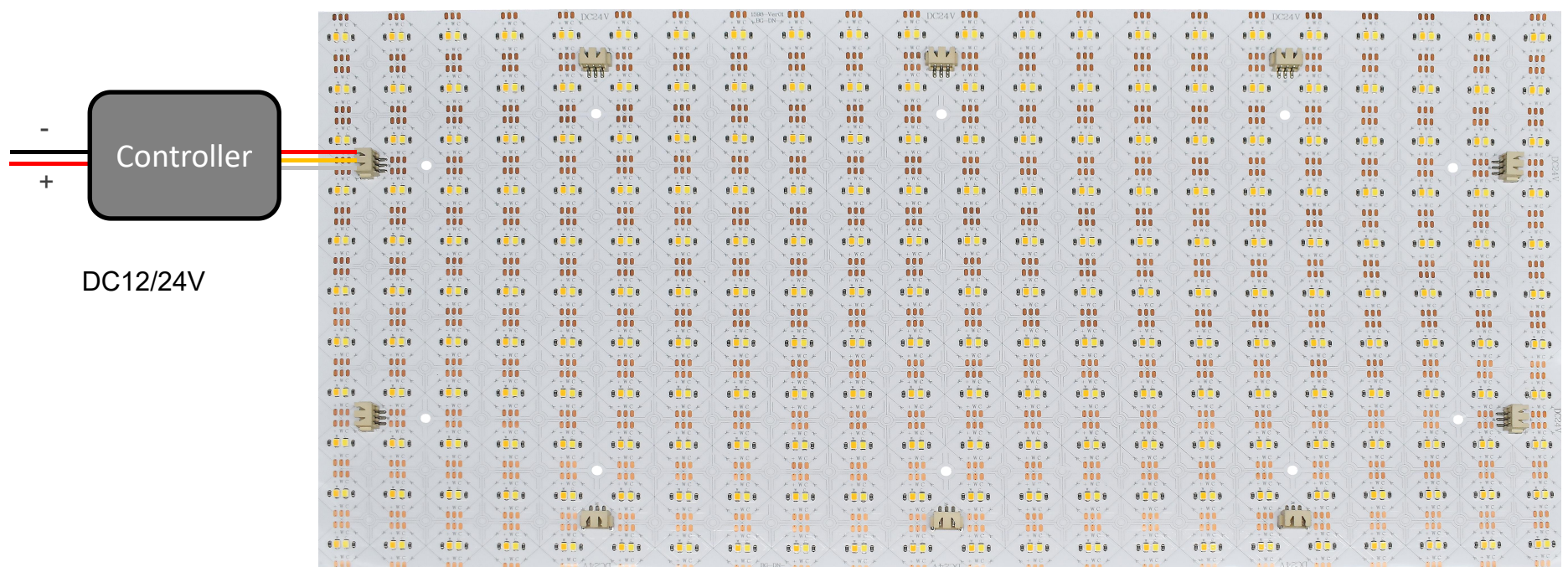

1. Connection method one

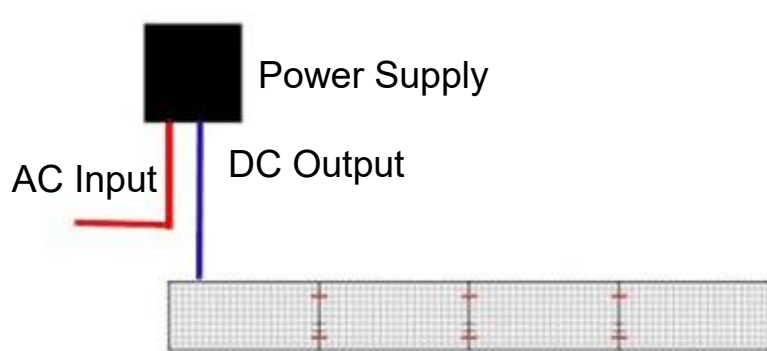

2. Connection method two

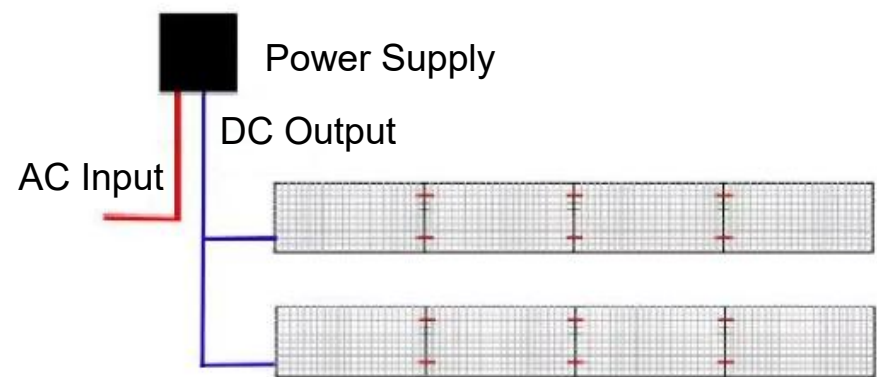

3. Connection method three

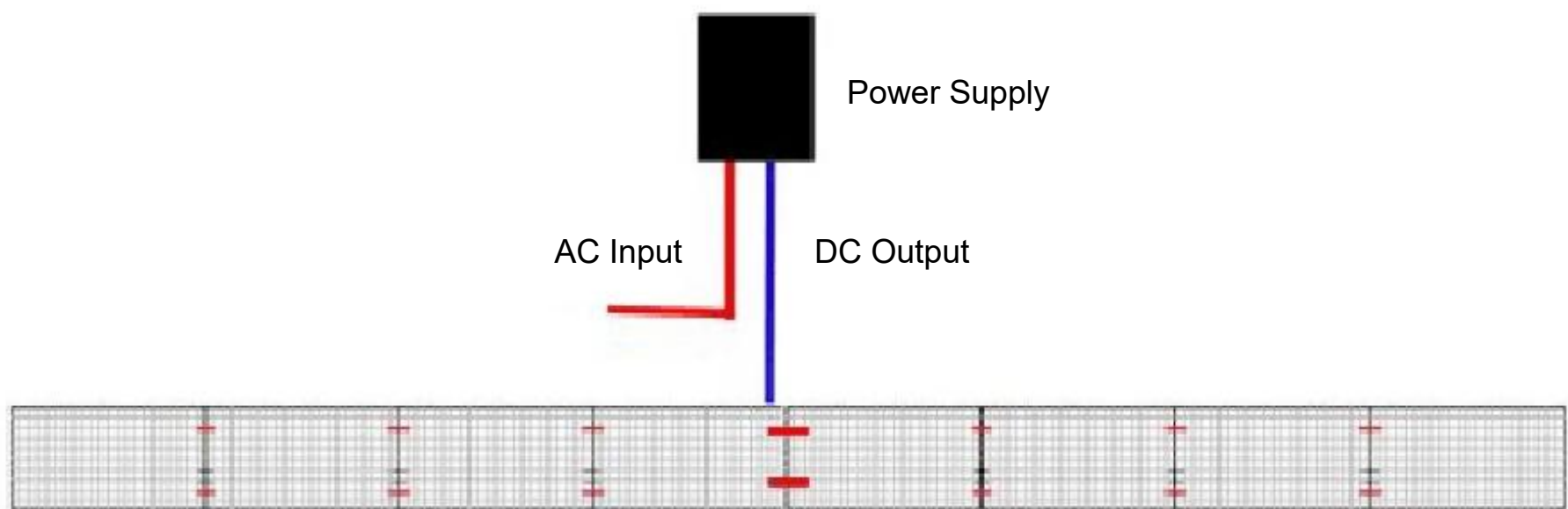

Accessories

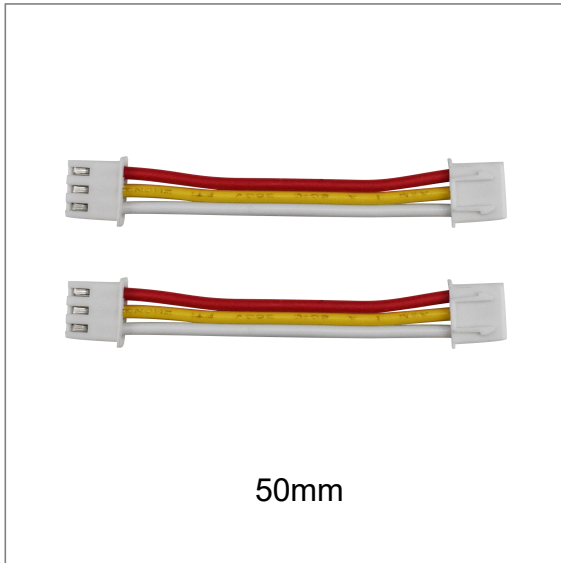

50mm

Connection piece*2

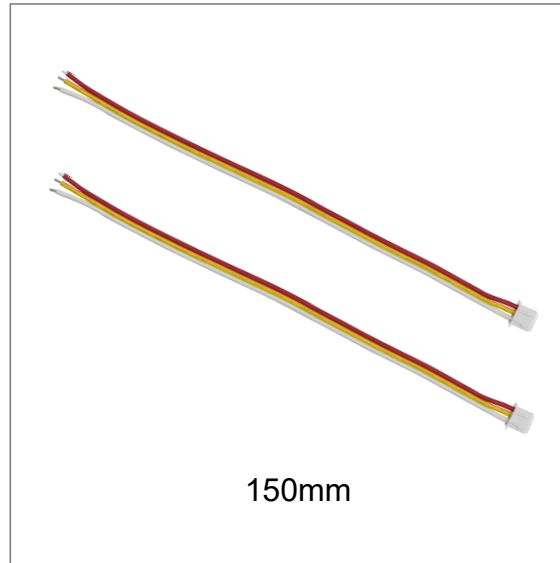

150mm

Connecting line*2



Anti-collision silicone particles*8

SUPERLIGHTINGLED

SuperLightingLED Limited was established in 2011 and has been in the LED field for 13 years. Now it has developed into a high-tech enterprise that is committed to growing to be a worldwide innovation brand of LED Lighting, providing up to 12,000 kinds of LED Strip Light products, covering almost all home lighting fields.

Website: <https://www.superlightingled.com/>