

TW1-4, TW2-4, TW4-4, TW5-4

RF DIM/CCT/RGB/RGBW/RGB+CCT

Wall Mounted Touch Panel



TW1-4
4 Zone Dimming



TW2-4
4 Zone CCT



TW4-4
4 Zone RGB/RGBW



TW5-4
4 Zone RGB+CCT

- Touch panel 1-5 color 4 zone RF remote.
- Each touch panel can remote control multiple RF 2.4G LED controllers.
- Ultra sensitive high strength glass touch panel with touch color wheel in the middle.
- Touch keys with LED indicator.
- Free installation, no wiring, removable.
- CR2032 battery powered.
- White & Black available.

CE RoHS LVD RED

1-5 color/Glass touch panel/Touch color wheel/Wireless remote 30m distance/CR2032 battery

Technical Parameters

Input and Output		Safety and EMC		Environment	
Output signal	RF(2.4GHz)	EMC standard (EMC)	ETSI EN 301 489-1 V2.2.3	Operation temperature	Ta: -30°C ~ +55°C
Working voltage	3VDC(CR2032)	Safety standard(LVD)	EN 62368-1:2020+A11:2020	Case temperature (Max.)	Tc: +65°C
Working current	<8mA	Radio Equipment(RED)	ETSI EN 300 328 V2.2.2	IP rating	IP20
Standby current	<16μA	Certification	CE,EMC,LVD,RED	Package	
Standby time	1 year	Warranty	5 years	Size	L100x W92 x H16.5mm
Remote distance	30m (Barrier-free space)			Gross weight	0.137kg

Mechanical Structures and Installations

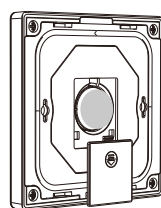
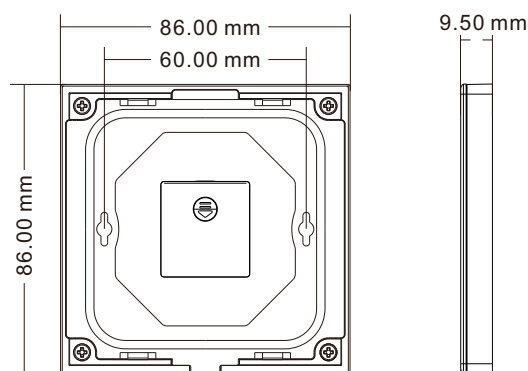

Installation diagram:

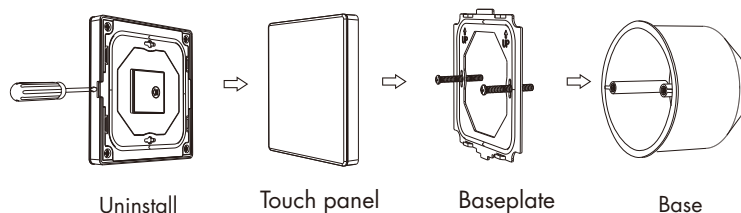

Note: If the LED indicator is not on when press key, it is due to dead battery or bad contact caused by multiple plugging, please replace the battery, or raise the battery shrapnel with a screwdriver

To fix the panel, three options are offered for selection:
 Option 1. fix it on the wall with two screws.
 Option 2. adhere it to the wall with paster.
 Option 3. panel can be adsorbed directly onto metal surfaces.

Match with RF LED controller (two match ways)

End user can choose the suitable match/delete ways. Two options are offered for selection:

Use the controller's Match key

Match:
 Short press match key, immediately press on/off key on the touch panel.
 The LED indicator fast flash a few times means match is successful.

Delete:
 Press and hold match key for 5s to delete all match.
 The LED indicator fast flash a few times means all matched remotes were deleted.

Use Power Restart





Match:
 Switch off the power, then switch on power, repeat again.
 Immediately short press on/off key 3 times on the touch panel.
 The light blinks 3 times means match is successful.

Delete:
 Switch off the power, then switch on power, repeat again.
 Immediately short press on/off key 5 times on the touch panel.
 The light blinks 5 times means all matched remotes were deleted.

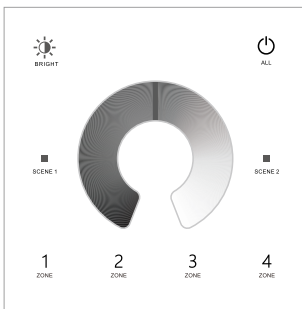
Key function





● TW1-4 4 zone dimming panel

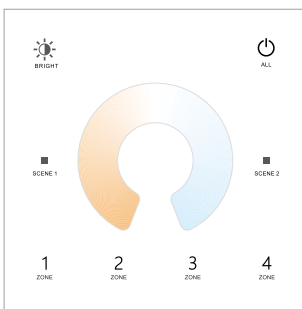

-  — Turn on/off all zone light.
-  — Adjust brightness, 10 levels.
-  — Touch to change brightness.
-  — Two scenes, short press recall the scene, long press 5s to save the current state into scene 1 / 2.
-  — Short press turn on zone light and select zone simultaneously, long press 2s turn off zone light. Short press multiple zone key fastly, will select multiple zone synchronously. 4 zone control separately or synchronously, each zone could control multiple receivers.







● TW2-4 4 zone CCT panel

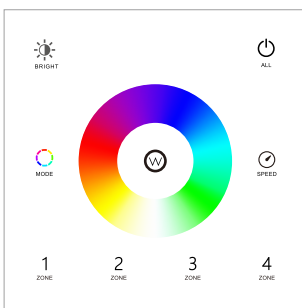

-  — Turn on/off all zone light.
-  — Adjust brightness, 10 levels.
-  — Touch to change color temperature.
-  — Two scenes, short press recall the scene, long press 5s to save the current state into scene 1 / 2.
-  — Short press turn on zone light and select zone simultaneously, long press 2s turn off zone light. Short press multiple zone key fastly, will select multiple zone synchronously. 4 zone control separately or synchronously, each zone could control multiple receivers.







● TW4-4 4 zone RGB/RGBW panel

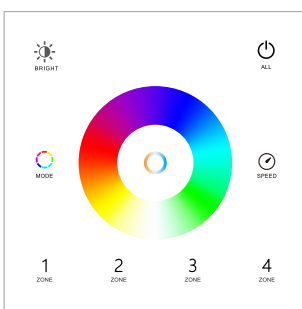

-  — Turn on/off all zone light.
-  — Adjust brightness, 10 levels.
-  — Short press run next dynamic mode, long press 2s run mode-cycle.
-  — For dynamic mode, adjust speed, short press 10 levels, long press 2s get the default speed. For static RGB color, adjust saturation, short press 11 levels, long press 1-6s for continuous adjustment.
-  — For RGB light, short press to get white (RGB mix). For RGBW light, short press to get white (W channel), long press 1-6s adjust W brightness.
-  — Touch to change static RGB color.
-  — Short press turn on zone light and select zone simultaneously, long press 2s turn off zone light. Short press multiple zone key fastly, will select multiple zone synchronously. 4 zone control separately or synchronously, each zone could control multiple receivers.

● TW5-4 4 zone RGB+CCT panel



-  — Turn on/off all zone light.
-  — Adjust brightness, 10 levels.
-  — Short press run next dynamic mode, long press 2s run mode-cycle.
-  — For dynamic mode, adjust speed, short press 10 levels, long press 2s get the default speed. For static RGB color, adjust saturation, short press 11 levels, long press 1-6s for continuous adjustment.
-  — Adjust color temperature, 11 levels.
-  — Touch to change static RGB color.
-  — Short press turn on zone light and select zone simultaneously, long press 2s turn off zone light. Short press multiple zone key fastly, will select multiple zone synchronously. 4 zone control separately or synchronously, each zone could control multiple receivers.

TW5-4 zone light type setting





Each zone can match single color, dual color(WW/CW), RGB/RGBW or RGB+CCT(WW/CW) controller.

Long press any of 1 2 3 4 key and any of four function key 2 seconds, will change one zone light type.



Long press any of  key and any of four function key 2 seconds, will change all four zone light type at the same time.



    +  : Long press 2 seconds, set 1, 2, 3 or 4 zone as single color type.

    +  : Long press 2 seconds, set 1, 2, 3 or 4 zone as dual color type.

    +  : Long press 2 seconds, set 1, 2, 3 or 4 zone as RGB/RGBW color type.

    +  : Long press 2 seconds, set 1, 2, 3 or 4 zone as RGB+CCT type.

 +  : Long press 2 seconds, set all 4 zone as single color type.

 +  : Long press 2 seconds, set all 4 zone as dual color type.

 +  : Long press 2 seconds, set all 4 zone as RGB/RGBW color type.

 +  : Long press 2 seconds, set all 4 zone as RGB+CCT type.

For example, If you want to change zone 1 light type as RGB type, please long press  and  key 2 seconds, When set is OK, the LED indicator will lighten red and blue.

TW1-4 and TW2-4 scene locking

- Scene keys can be set to locked state, cancel long press for 5 seconds to save the scene function (default scene is not locked).
- Short press the panel on/off key, turn on the light first, then turn off the light, immediately long press the panel on/off key for 5 seconds, then immediately long press any one scene key for 5 seconds to set all scene keys to locked state.
- Short press the panel on/off key, turn on the light first, then turn off the light, immediately long press the panel on/off key for 5 seconds, then immediately long press any one scene key for 10 seconds to restore all scene keys to unlocked state.

Safety information

1. Read all instructions carefully before you begin this installation.
2. When installing battery, pay attention to the battery positive and negative polarity.
A long time without the remote control, remove the battery.
When remote distance becomes smaller and insensitive, replace the battery.
3. If no response from the receiver, please re-match the remote.
4. Gently handle remote, beware of falling.
5. For indoor and dry location use only.