





Hand Sweep / Door Control Sensing Switch

Model List

CE RoHS  LVD

Model	Product name	Product picture	Input/Output jack	Sensor data
EB-CV(D)	Hand sweep sensing switch		DC female jack in DC male jack out	Sensitive field: ≤7cm Dimming range: 5 -100% Dimming curve: Logarithmic
EB-CV(L)	Hand sweep sensing switch		Dupont male jack in Dupont female jack out	
ED-CV(D)	Door sensing switch		DC female jack in DC male jack out	Sensitive field: ≤5cm
ED-CV(L)	Door sensing switch		Dupont male jack in Dupont female jack out	

Features

- Concealed aluminum housing hand sweep /door control sensing switch, constant voltage output, connect with low voltage LED strip.
- Maximum 4A output current, maximum power 96W@24V.
- Output PWM frequency: 2000Hz.
- 1 second on/off light fade.
- Apply to cabinet, closet, wine cabinet and other lighting.

Technical Parameters

Output and Input		Environment and Protection		Safety and EMC	
Input voltage	12-24VDC	Operation temperature	Ta: -30°C ~ +50 °C	EMC standard (EMC)	ETSI EN 301 489-1 V2.2.3
Output voltage	12-24VDC	Protection	Reverse polarity	EMC standard (EMC)	ETSI EN 301 489-17 V3.2.4
Output current	Max. 4A	Package		Safety standard (LVD)	EN 62368-1:2020+A11:2020
Output power	48-96W	Size	L80xW45xH30mm	Certification	CE,EMC,LVD
PWM frequency	2000Hz	Gross weight	0.035kg		

Wiring Diagram

(1) DC Plug Connection

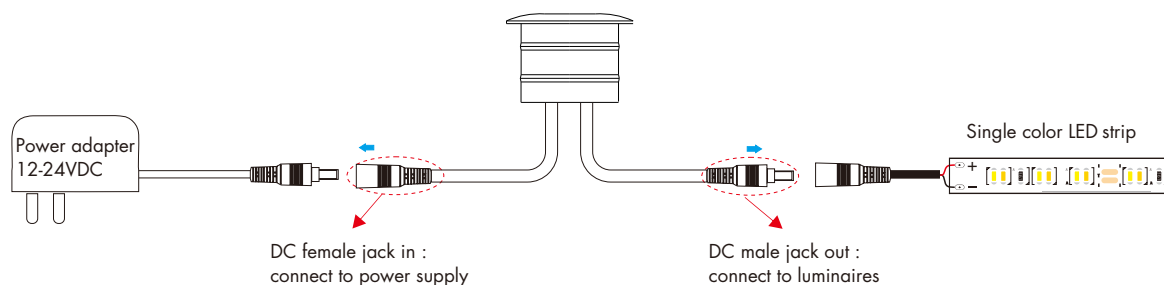

(2) Dupont wire connection

- Power supply with constant voltage power supply + junction box

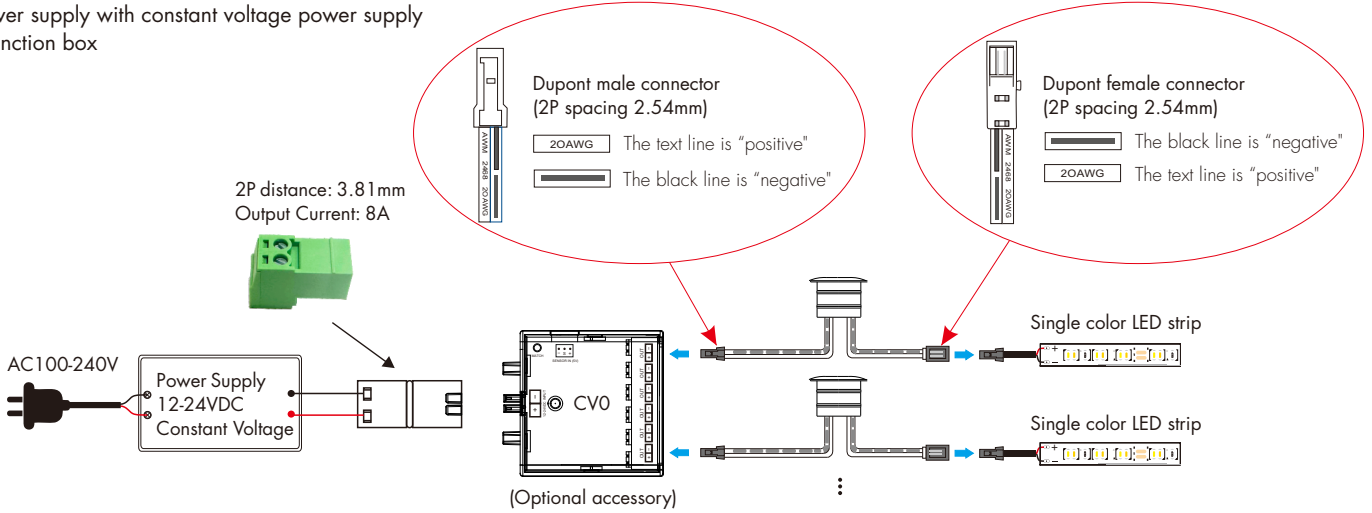

Note: because the output current of the terminal block is 8A, the maximum current of each output of the junction box is 2A. Therefore, using constant voltage power supply, the output can be connected to 4 LED strips.

- Power supply using cabinet constant voltage power supply + junction box

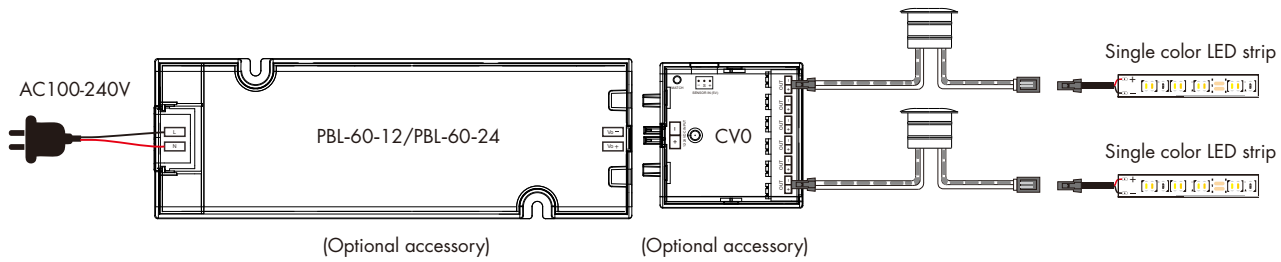

Note: cabinet power supply PBL-60-12 output current is 5A, junction box output maximum current is 2A each way. So the output can connect 2 LED strips. cabinet power supply PBL-60-24 output current is 2.5A, junction box output maximum current is 2A per circuit. So the output can connect 1 LED strip.

Sensing switch installation

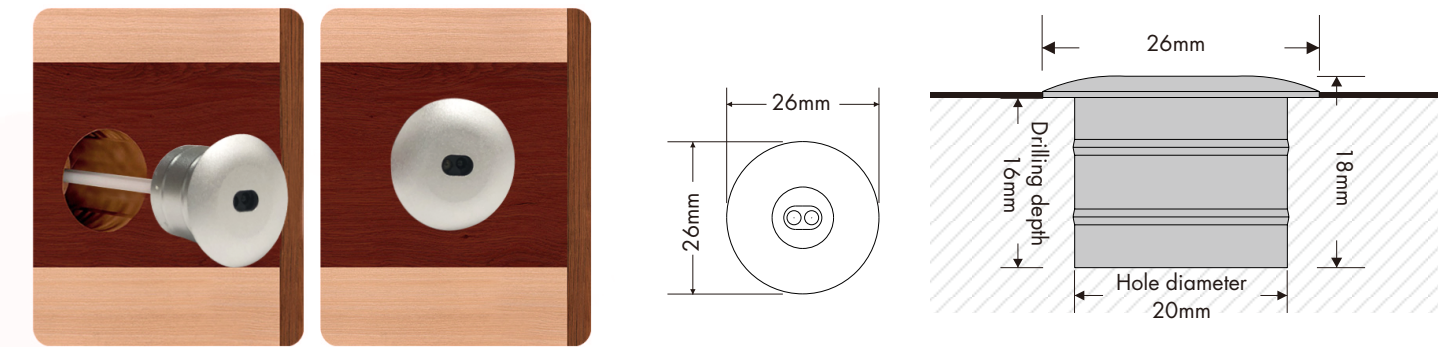

1. Make a 20mm diameter hole.
2. Place the sensing switch into the hole.

Sensing switch application

EB-CV: Hand sweep sensing switch

Make pendulum action at the front end of the sensing switch:
 when hand sweep, the light turn on gradually;
 when hand sweep again, the light turn off gradually.

Hold your hand in front of the sensing switch for more than 2 seconds:
 The brightness increases or decreases continuously,
 the each time the hand is removed and then held again,
 the brightness changes in the opposite direction.

ED-CV: Door sensing switch

When the door open, or no obstacle in front of the sensing switch,
 the light turn on gradually;
 When the door close, or obstacle in front of the sensing switch,
 the light turn off gradually.