

Dual Touch Button Remote Control

- 1-5 color dual touch button remote control, suitable for single color, color temperature, RGB, RGBW or RGB+CCT LED RF controller.
- Turn on/off the light, adjust the brightness, color temperature, RGB color by touch two buttons.
- Operate with LED indicator light.
- CR2450 battery powered.
- Apply to cabinet, closet, wine cabinet and other lighting.



CE RoHS  RED

Technical Parameters

Input and Output		Environment		Safety and EMC	
Output signal	RF(2.4GHz)	Operation temperature	Ta: -30°C ~ +50°C	EMC standard(EMC)	ETSI EN 301 489-1 V2.2.3 ETSI EN 301 489-17 V3.2.4
Control distance	30m(Barrier free space)			Safety standard	EN 61348-1:2015+A1:2021 EN 61348-2-13:2014+A1:2017
Work voltage	3VDC (CR2450)	Package		Radio Equipment(RED)	ETSI EN 300 328 V2.2.2
Work current	<6mA	Size	80x40x30mm	Certification	CE, EMC, RED
Standby current	<20μA	Gross weight	0.035kg		

Mechanical Structures and Installations

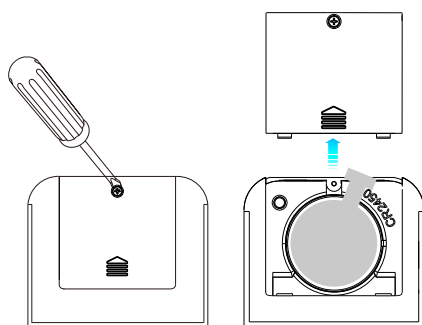
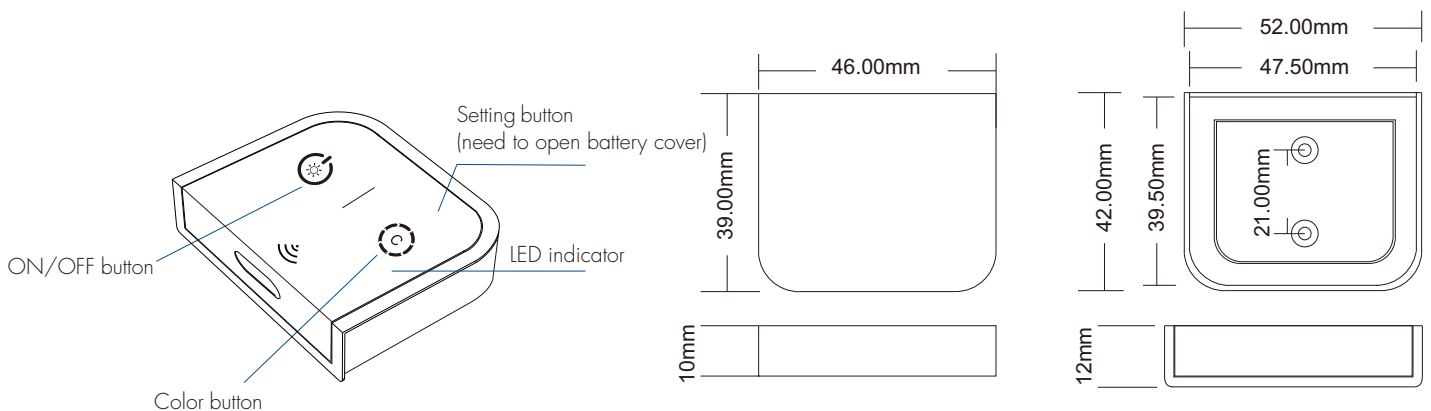

Note: Before the first use, please remove the protective film on the battery.

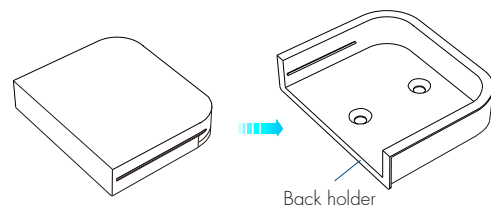

To fix the remote, two options are offered for selection:
 1. fix the remote' back holder on the wall with two screws
 2. adhere it to the wall with paster.

Light type setting

The remote control is compatible with five light types.

Short press setting button to switch five light type in sequence:

1. DIM light type, the LED indicator light flashes 1 time.
2. CCT light type, the LED indicator light flashes 2 times.
3. RGB light type, the LED indicator light flashes 3 times.
4. RGBW light type, the LED indicator light flashes 4 times.
5. RGB+CCT light type, the LED indicator light flashes 5 times.

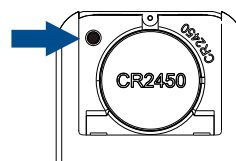

Note:

The factory default DIM light type.

Touch detection will stop when you press the button to set the light type.

Dual Button Remote Control Installation

1. Use screws or 3M adhesive to fix the installation:

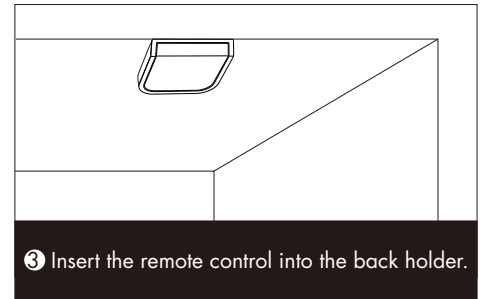
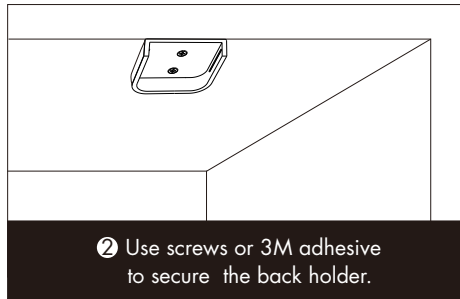
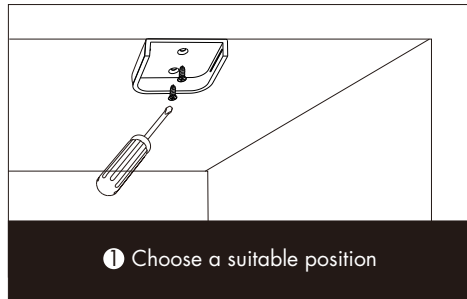

2. Slotted recessed installation:

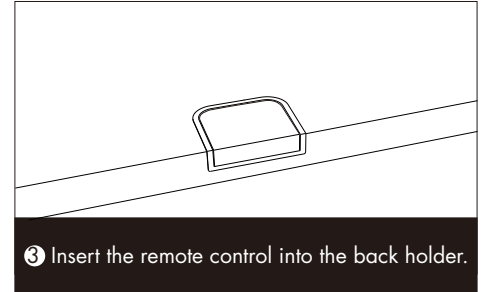
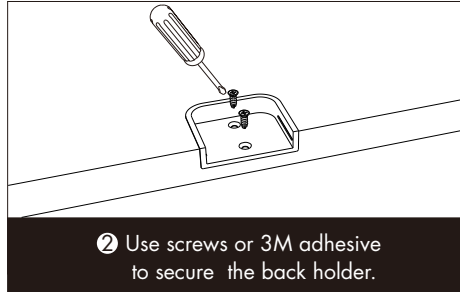
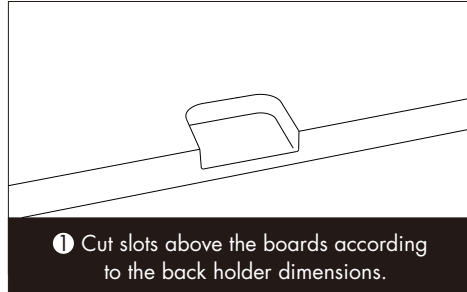

Touch Key Function

1. DIM light type

- Short press: Turn on/off the light.
- Short press: Sequenal switching 5 levels brightness (10%, 25%, 50%, 75%, 100%).
- Long press (1-6s): Step-less dimming, with every other long press, the light level goes to the opposite direction.

2. CCT light type

- Short press: Turn on/off the light.
- Long press (1-6s): Step-less dimming, with every other long press, the light level goes to the opposite direction.
- Short press: Sequenal switching 5 levels color temperature (warm white - neutral white - cold white).
- Long press (1-6s): Adjust the color temperature continuously, with every other long press, the color temperature goes to the opposite direction.

3. RGB light type

- Short press: Turn on/off the light.
- Long press (1-6s): Step-less dimming, with every other long press, the light level goes to the opposite direction.
- Short press: Switch between color light (RGB) and mixed white light (current color light + 50% saturation).
- at the same time, enter the state of long press to adjust color light or saturation.
- Long press (1-6s): Adjust color light or saturation continuously, with every other long press, goes to the opposite direction.

4. RGBW light type

- Short press: Turn on/off the light.
- Long press (1-6s): Step-less dimming, with every other long press, the light level goes to the opposite direction.
- Short press: Switch between color light (RGB) and white light (W).
- at the same time, enter the state of long press to adjust color light or white light brightness.
- Long press (1-6s): Adjust color light or white light brightness continuously, with every other long press, goes to the opposite direction.

5. RGB+CCT light type

- Short press: Turn on/off the light.
- Long press (1-6s): Step-less dimming, with every other long press, the light level goes to the opposite direction.
- Short press: Switch between color light (RGB) and color temperature.
- at the same time, enter the state of long press to adjust color light or color temperature.
- Long press (1-6s): Adjust color light or color temperature continuously, with every other long press, goes to the opposite direction.

RF LED Controller Match Dual Touch Button Remote Control

End user can choose the suitable match/delete ways. Two options are offered for selection:

Use the controller's Match key

Match:
Short press match key of the controller, immediately short press the ON/OFF button on the remote controller. The LED indicator fast flash a few times means match is successful.

Delete:
Press and hold match key of the controller for 5s, The LED indicator fast flash a few times means match was deleted.

Use Power Restart

Match:
Switch off the power of the controller, then switch on power, repeat again. Immediately short press the ON/OFF button on the remote controller 3 times. The controller output light blinks 3 times means match is successful.

Delete:
Switch off the power of the controller, then switch on power, repeat again. Immediately short press the ON/OFF button on the remote controller 5 times. The controller output light blinks 5 times means match was deleted.