

Dual PIR Sensor + Dual Push Button SPI Controller

- Dual PIR sensor + dual push button input RGB or white light SPI controller features daylight sensor.
- Two groups same SPI(TTL) signal output, drive 28 kinds IC digital RGB or white LED strip, IC type and R/G/B order can be set.

Compatible ICs:

TM1804, TM1809, TM1812, UCS1903, UCS1909, UCS1912, UCS2903, UCS2909, UCS2912, WS2811, WS2812, TM1829, TM1914A, GW6205, GS8206, GS8208, LPD6803, LPD1101, D705, UCS6909, UCS6912, LPD8803, LPD8806, WS2801, WS2803, P9813, SK9822, SM16703P.

- When applied to stair light, supports four output modes: color flow, white flow, color step, white step.
- Sequential switching control is realized when multiple SPI controllers are connected to a single self-resetting push switch button.
- Multiple light colors and change types are selectable with adjustable speed and brightness.

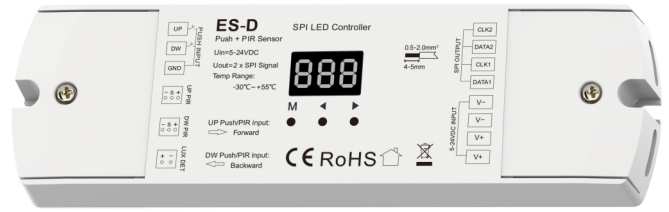

Technical Parameters

Input and Output		Sensor data		Safety and EMC	
Input voltage	5-24VDC	Sensitive field	≤3m	EMC standard (EMC)	ETSI EN 301 489-1 V2.2.3 ETSI EN 301 489-17 V3.2.4
Input current	1.5A	Sensitivity angle	30°(±10°)	Safety standard	EN 62368-1:2020+A1 1:2020
Output signal	2 X SPI(TTL)	Environment		Certification	CE, EMC
Pixel number	Max 960	Operation temperature	Ta: -30°C ~ +55°C	Package	
Input signal	PIR sensor + Push button	Case temperature (Max.)	Tc: +65°C	Size	L175 x W120 x H35mm
Warranty		IP rating	IP20	Gross weight	0.27kg
Warranty	5 years				

Mechanical Structures and Installations

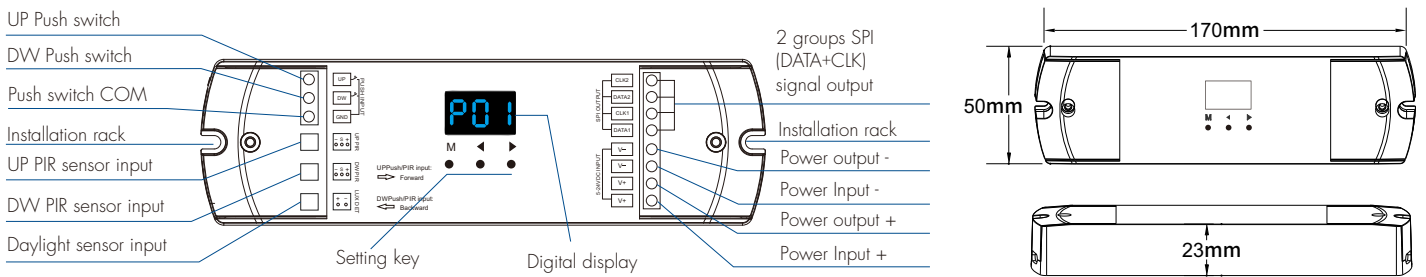

Wiring Diagram

1. Stair light application, connect with PIR sensor, color or white light flow control

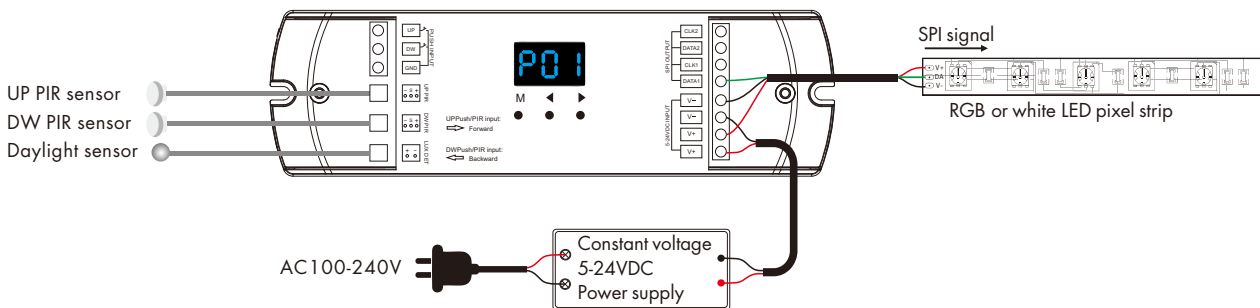

2. Stair light application, connect with PIR sensor, color or white light step control

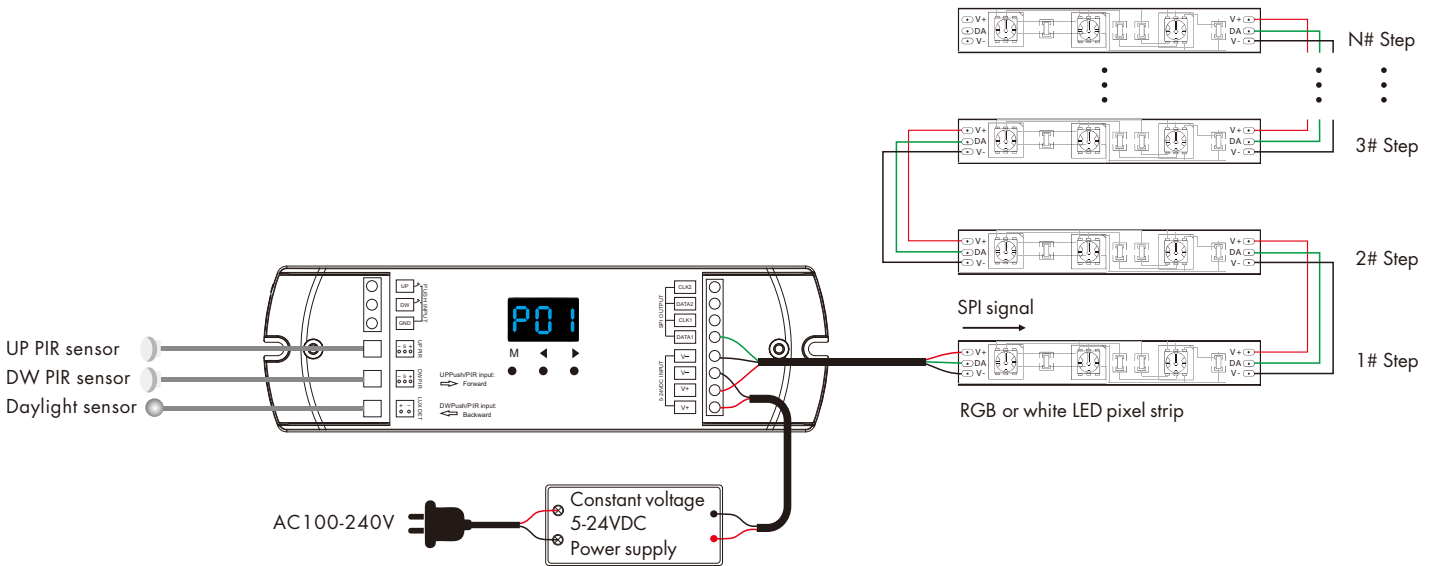

3. One push switch connect with multiple controllers for sequential switching control

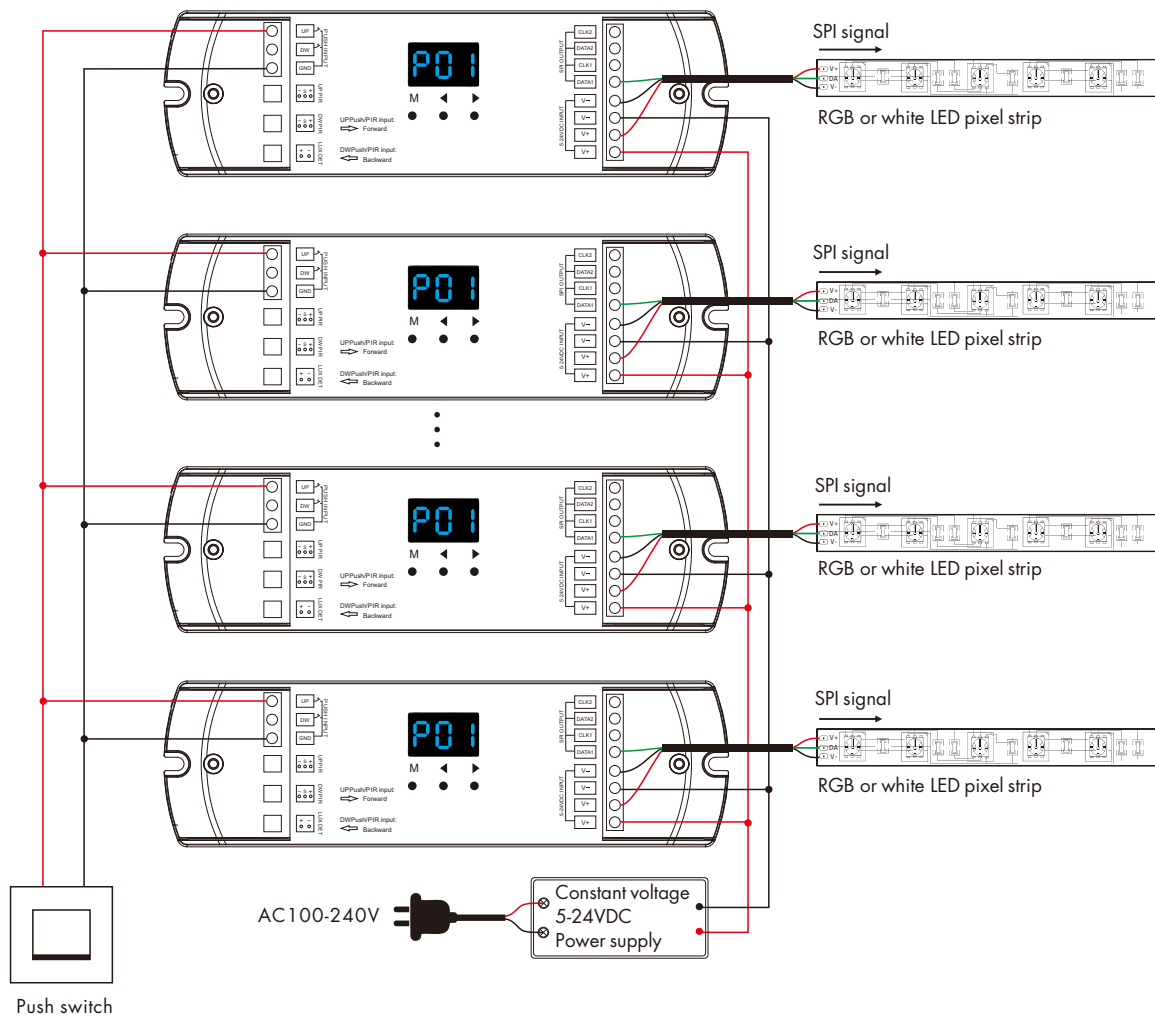

- Note:**
1. If the SPI LED strip is a single-wire control method, the DATA and CLK signal line outputs of the controller are same, and one controller can connect four LED strips.
 2. If the SPI LED strip is a dual wire control method, one controller can connect two LED strips.
 3. When the SPI strip load does not exceed 15A, the same power supply can simultaneously power the ES-D controller and the SPI strip at the same time.
When the load on the SPI strip exceeds 15A, separate power supplies are required for the ES-D controller and the SPI strip.
Only DATA and GND signal lines are connected between ES-D controller and SPI strip.
 4. The PIR sensor can be replaced with a stair infrared reflection sensor(ES-T) or other sensors that output 5V level signals.
 5. The color or white light flow model can control up to 960 pixel points of SPI strip.
 6. The color or white light step model defaults to 30 steps with 10 pixels per step. the step number x pixel length per step must ≤ 960 .

Parameters Setting

1. Long press the M and ◀ key for 2s simultaneously, enter the light parameters setting state: set the light type, LED strip connection mode (flow or step) pixel length, step number, light on/off mode, sensor turn off light delay time, daylight detection, self-reset push switch turn on or off light delay time.

(1) Light type setting

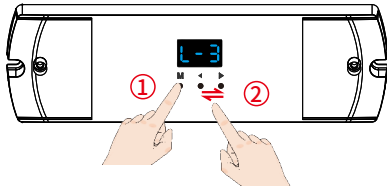

- ① Short press M key enter light type setting interface;
- ② Short press ◀ or ▶ key to switch light type.

3-bead white light: 1 pixel with 3 same data, control 3-bead white LED, display "L-1".

1-bead white light: 1 pixel with 1 data, control 1-bead white LED, display "L-2".

RGB color light: 1 pixel with 3 data, control one R/G/B LED, display "L-3".

(2) LED strip connection mode setting

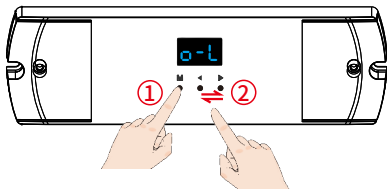

- ① Short press M key enter LED strip connection mode setting interface;
- ② Short press ◀ or ▶ key to switch LED strip connection mode.

Flow mode: Straight line digital pixel LED strip connection mode, display "o-L".

Step mode: Z-shape digital pixel LED strip connection mode, display "o-S".

(3) Pixel length setting

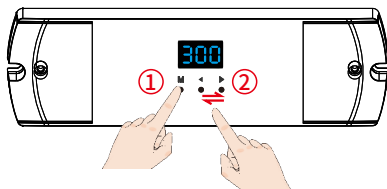

- ① Short press M key enter pixel length setting interface;
- ② Short press ◀ or ▶ key to set the pixel length.

Pixel length:

For color or white flow mode, set the number of pixel points, the range is 032-960, display "032"-960".

(4) Step number and step pixel length setting

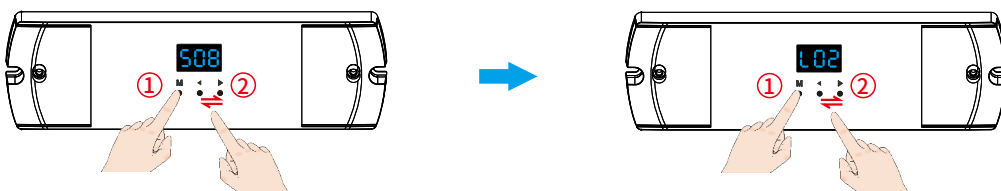

- ① Short press M key enter step number setting interface;
- ② Short press ◀ or ▶ key to set the step number.

- ① Short press M key enter step pixel length setting interface;
- ② Short press ◀ or ▶ key to set the step pixel length.

Step numbers and step pixel length:

For color or white step mode, set the number of steps and pixel dot number of each step.

Step number: the range is 8-99, display "S08"-S99";

Pixel dot number of each step: the range is 2-99, display "L02"-L99".

the step number x pixel dot number of each step number must ≤ 960 .

(5) Light on/off mode setting(i.e.,set the sensor activated and self-reset button to turn on or off the light mode (Table 1))

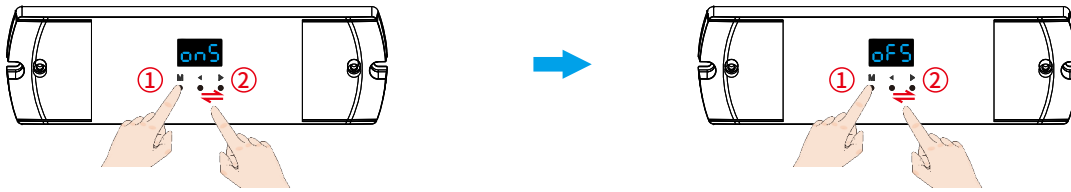

- ① Short press M key enter light on setting interface;
 ② Short press ◀ or ▶ key to switch two light on mode:

Sequential light on:

Light turn on sequentially from the beginning to the end, display "onS" .

Synchronized light on:

Light turn on synchronously, display "onC" .

- ① Short press M key enter light off setting interface;

- ② Short press ◀ or ▶ key to switch three light off mode:

Sequential light off:

Light turn off sequentially from the beginning to the end, display "oFS" .

Sequence light off in reverse:

Light turn off sequentially from end to beginning, display "oFb".

Synchronized light off:

Light turn off synchronously, display "oFC" .

List of ways to turn on/off light combinations:

Display	Name
onS + oFS	Sequential light on, sequential light off
onS + oFb	Sequential light on, sequential reverse light off
onS + oFC	Sequential light on, synchronized light off
onC + oFS	Synchronized light on, sequential light off
onC + oFb	Synchronized light on, sequential reverse light off
onC + oFC	Synchronized light on, synchronized light off

(Table 1)

(6) Sensor delay off time setting

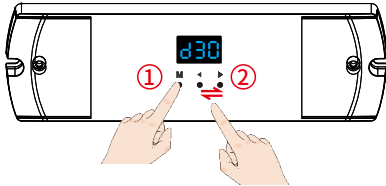

- ① Short press M key enter sensor delay off time setting interface;
 ② Short press ◀ or ▶ key to switch 10 levels delay time.

Sensor delay off time:

5sec (d05), 10sec (d10), 30sec (d30), 1min (01d), 3min (03d),
 5min (05d), 10min (10d), 30min (30d), 60min (60d), cancel (d00),
 set cancel means not turn off the light.

(7) Daylight detection setting

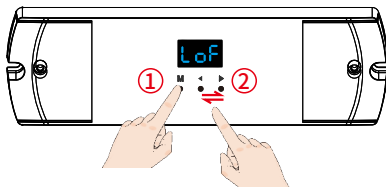

- ① Short press M key enter daylight detection setting interface;
 ② Short press ◀ or ▶ key to switch 6 levels daylight detection.

Daylight detection:

Set the light sensing detection threshold (6 levels):

10Lux (Lu1), 30Lux (Lu2), 50Lux (Lu3), 100Lux (Lu4), 150Lux (Lu5), 200Lux (Lu6), Off (LoF).

Factory default light sensing detection is Off (LoF).

When light sense detection is on, PIR sense turns on the light only when the ambient light is lower than threshold value.

(8) Self-reset push switch turn on or off light delay time setting



- ① Short press M key enter push switch turn on light delay time setting interface;
- ② Short press ◀ or ▶ key to set the delay time.

- ① Short press M key enter push switch turn off light delay time setting interface;
- ② Short press ◀ or ▶ key to set the delay time.

Self-reset push switch turn on light delay time:

Setting range 0-15.5s, the smallest unit 0.5s, display "o00"-o95"-oF5",
A-F indicates that 10-15s.
Setting 0s means turn on light immediately.

Self-reset push switch turn off light delay time:

Setting range 0-15.5s, the smallest unit 0.5s, display "c00"-c95"-cF5",
A-F indicates that 10-15s.
Setting 0s means turn off light immediately.

2. Long press the M and ▶key for 2s simultaneously, enter the LED strip parameters setting state: set the chip type, RGB color order.

(1) Chip type setting

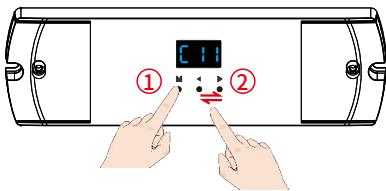

- ① Short press M key enter the chip type setting interface;
- ② Short press ◀ or ▶ key to switch chip type (Table 2).

LED strip IC types list:

No.	IC type	Compatible IC type	Output signal
C11	TM1809	TM1804, TM1812, UCS1903, UCS1909, UCS1912, UCS2903, UCS2909, UCS2912, WS2811, WS2812, SM16703P	DATA
C12	TM1829		DATA
C13	TM1914A		DATA
C14	GW6205		DATA
C15	GS8206	GS8208	DATA
C21	LPD6803	LPD1101, D705, UCS6909, UCS6912	DATA, CLK
C22	LPD8803	LPD8806	DATA, CLK
C23	WS2801	WS2803	DATA, CLK
C24	P9813		DATA, CLK
C25	SK9822		DATA, CLK

(Table 2)

(2) RGB color order setting

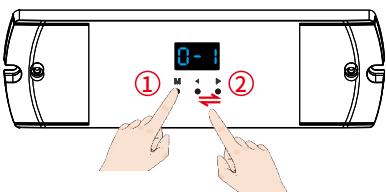

- ① Short press M key enter the RGB order setting setting interface;
- ② Short press ◀ or ▶ key to switch R/G/B order (Table 3).

LED strip RGB color order:

R/G/B order	RGB	RBG	GRB	GBR	BRG	BGR
Digital display	0-1	0-2	0-3	0-4	0-5	0-6

(Table 3)

3. Quit the parameter setting

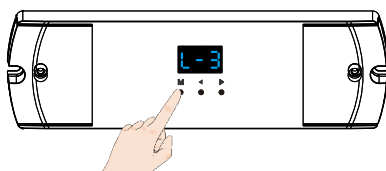

Long press the M key for 2s or wait for 15s, quit the parameter setting state.

Light effect settings

(1) Light color setting

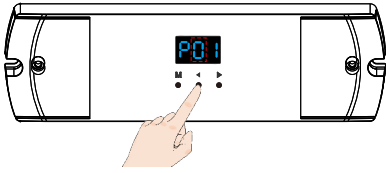

Short press ◀ key to switch 10 light colors in sequence (Table 4).



Color Flow/Color Step mode, the digit shows P01~P95.

(2) Light change type setting

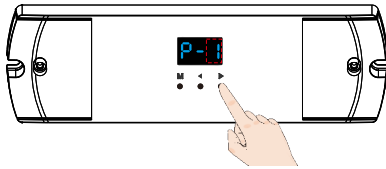

Short press ▶ key to switch 5 light change types in sequence (Table 5).



White Flow/White Step mode, the digit shows P-1~P-5.

(3) Light effect parameter setting (i.e., speed, brightness, Self-defined R/G/B color)

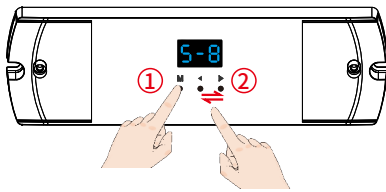

① Short press M key to switch three parameter items;

② Short press ◀ or ▶ key to adjust the value of each parameter item.

Speed, brightness, and self-defined R/G/B color parameter value description:

Speed: 1-8 levels adjustable, display "S-1"-"S-8", S-8 is the maximum speed.

Brightness: 1-10 level adjustable, display "b10"-"bFF", bFF means maximum brightness 100%.

Self-defined R/G/B color: 0-255 (00-FF) adjustable.

R channel displays "100"-"1FF"; G channel displays "200"-"2FF"; B channel displays "300"-"3FF".

Color type (2nd digit):

NO.	Name
0	Rxxx Gxxx Bxxx (User define)
1	Red
2	Orange
3	Yellow
4	Green
5	Cyan
6	Blue
7	Purple
8	R/G/B 3 color
9	7 color

(Table 4)

Color/white light change type (3rd digit):

NO.	Name
1	Flow
2	Chase
3	Float
4	Trail
5	Trail+black section

(Table 5)

(4) Quit light effect parameter setting

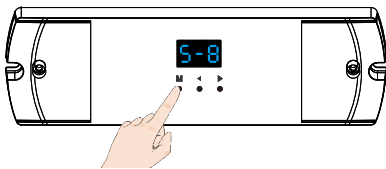

Long press the M key for 2s or wait for 15s, quit the light effect parameter setting state.

Note:

1. White flow / white step mode does not support self-defined R/G/B color function.
2. For color flow / color step mode, the light color and light change type are combined to form 50 kinds of light effects.
3. For color flow / color step / white flow / white step mode, can be adjusted in speed and brightness.

Factory Default Parameter setting

- Long press ◀ and ▶ key for 2s simultaneously, restore factory default parameters, display "RES".
- Factory default parameters: RGB color light flow output, 300 pixels, sequential light on, sequential light off, 30s delay off time, disable daylight detection, push switch turn on delay and turn off delay is 0s, chip type TM1809, RGB order.

Typical application

1. Dual PIR sensing

- Connect two PIR sensors to realize automatic staircase light control.
- The UP PIR sensor is installed at the bottom of the staircase, when sensing a person, the digital tube instantly displays "u", the light is automatically turned on, and the light is turned off with a delay.
- The DVV PIR sensor is installed at the top of the staircase, when sensing a person, the digital tube instantly displays "d", the light is automatically turned on, and the light is turned off with a delay.
- If you set the daylight sensor detection on, the light will be turned on only in darker environment or at night.

2. Dual self-reset push switch control

- Connect two push switches for manual control of stair lights.
The UP push switch is installed at the bottom of the stairs; the DVV push switch is installed at the top of the stairs.
- Set the self-reset push switch to 0s for both light on delay and light off delay.
Short press the self-reset push switch to turn on the light, display the current light effect mode;
short press the self-reset push switch again, turn off the light, display "OFF".
Long press the UP self-reset push switch to adjust the brightness, range 10-100%, digital tube display "b10"-"bFF".
Note: The DVV self-reset push switch does not have the function of adjusting the brightness.
- Using self-reset push switch control will ignore the daylight sense detection.

3. Self-reset switch connects multiple controllers for sequential switching control

- Multiple controllers are connected to one or two push switches at the same time to realize sequential switching control.
- Set the self-reset push switch light on/off delay time of multiple controllers to incremental or decremental values, for example: set 1-4# controllers' push switch light on delay time to 0s, 1s, 2s, 3s respectively, and push switch light off delay time to 3s, 2s, 1s, 0s respectively. In this way, 1-4# controllers will turn on the lights in the same order, and turn off the lights in the reverse order.
- Short press the self-reset push switch to turn on the lights sequentially. during the delayed light on time, digital display "don".
When the light on, display the current light dynamic mode.
- Short press the self-reset push switch again to turn off the lights sequentially. during the delayed light off time, digital display "doF".
When the lights off, digital display "OFF".

Note:

- When the lighting effects of multiple controllers are confused, it can be quickly restored by double-click the self-reset push switch.
- Using the self-reset switch to control multiple controllers will ignore the sensor delay off time and daylight detection settings.

Installation of PIR sensor

Size of detector:

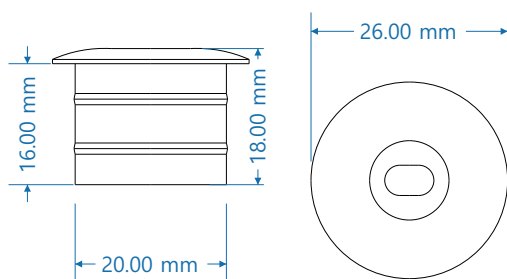

PIR sensor detection scope ($\pm 10^\circ$ Error):

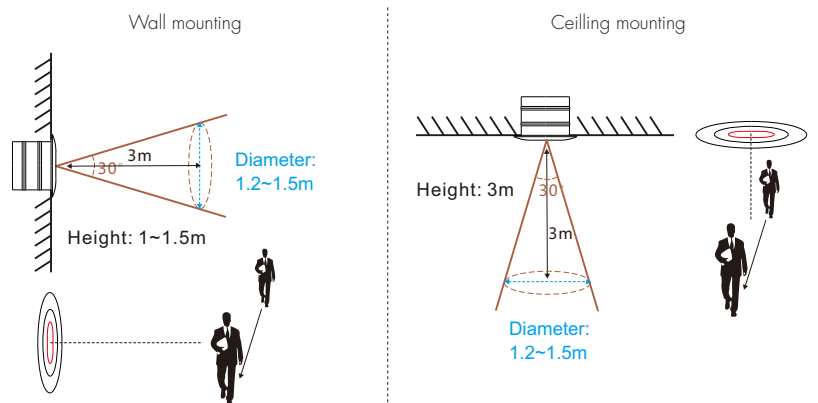

★ For wall mounting and ceiling mounting, note that the sensing holes are perpendicular to the direction of human movement.

Notice for installation of PIR sensor

1. Recommended for wall mounting.
2. If the sensor is exposed to direct sunlight, interference signal will be introduced.
3. The sensor should be installed in a dry environment and keep away from windows, air conditioner and fans.
4. Make sure that the sensor stays away from heat source, such as countertops, kitchen appliances which generate hot steam, walls and windows in direct sunlight, air conditioner, heating, refrigerators, stoves and so on.
5. We recommended the wall-mounted installation height is 1-1.5 meters and the ceiling mounting height is no more than 3 meters.
6. There should not be shelter(screen, furniture, large bonsai) within the range of detection.

Packing List



LED Controller
1 pcs

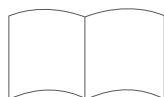

User Manual
1 pcs



Daylight sensor (30cm)
1 pcs



PIR sensor
2 pcs



PIR sensor extension line (5m)
2 pcs