

Intelligent LED Driver (Constant Voltage)

- Small size and light weight. The housing is made from V0 flame retardant PC materials that SAMSUNG/COVESTRO uses.
- The clamshell design and screwless type for strain-relief. The design of dismountable end cap allows you to adjust the length of housing depending on your needs.
- With soft-on and fade-in dimming function, enhancing your visual comfort.
- Dimming from 0~100%, down to 0.1%.
- Support Leading edge (Triac), Trailing edge (ELV) and Push DIM.
- Energy-efficient driver: Efficiency 87%, PF>0.98, THD<5%.
- The secure and reliable design for signal isolation.
- Innovative thermal management technology intelligently protects the power life.
- Overheat, over voltage, overload, short circuit protection and automatic recovery.
- Suitable for indoor light applications of I/II/III type.
- Up to 50,000-hour life time.
- 5-year warranty (Rubycon capacitor).

Flicker-free
IEEE 1789

Dimmable:
0.1%~100%



Use only within an enclosure. The certification icon represents on-going certification applications only, and final certification qualification is subject to actual products.

Technical Specs

| Model | LM-60-24-L1T2 | LM-60-12-L1T2 | | |
|----------------------|-----------------------------------|--|---|--|
| OUTPUT | Output Voltage | 24Vdc | 12Vdc | |
| | Output Voltage Range | 24Vdc±0.5Vdc | 12Vdc±0.5Vdc | |
| | Output Current | Max. 2.5A | Max. 5A | |
| | Output Power | Max. 60W | | |
| | Output Power Range | 0-60W | | |
| | Strobe Level | High frequency exemption level | | |
| | Dimming Range | 0~100%, down to 0.1% | | |
| | Overload Power Limitation | ≥102% | | |
| | Ripple | ≤0.25V | ≤0.5V | |
| | PWM Frequency | 3600Hz | | |
| INPUT | Dimming Interface | Triac/ELV, Push DIM | | |
| | Input Voltage | 108-132Vac | | |
| | Frequency | 50/60Hz | | |
| | Input Current | ≤0.67A/120Vac | | |
| | Power Factor | PF>0.98/120Vac (at full load) | | |
| | THD | THD<5%/120Vac (at full load) | | |
| | Efficiency (typ.) | 87% | 86% | |
| | Standby Power Loss | <0.5W | | |
| | Inrush Current | Cold start 25A/120Vac (Test twidth=340us under 50% Ipeak) | | |
| | Anti Surge | L-N: 2KV | | |
| | Leakage Current | Max. 0.5mA | | |
| ENVIRONMENT | Working Temperature | ta: -20~50°C tc: 85°C | | |
| | Working Humidity | 20-95%RH, non-condensing | | |
| | Storage Temperature, Humidity | -40~80°C, 10-95%RH | | |
| | Temperature Coefficient | ±0.03%/°C(-20~50°C) | | |
| | Vibration | 10~500Hz, 2G 12min/1cycle, 72 min for X, Y and Z axes respectively | | |
| PROTECTION | Overheat Protection | Intelligently adjust or turn off the output current if the PCB temperature ≥110°C, and recover automatically | | |
| | Overload Protection | Shut down the output when current load>102%, and recover automatically | | |
| | Short Circuit Protection | Enter hiccup mode if short circuit occurs, and recover automatically | | |
| | Overvoltage Protection | Shut down the output when non-load voltage>26V, and recover automatically | Shut down the output when non-load voltage>13V, and recover automatically | |
| SAFETY & EMC | Withstand Voltage | I/P-O/P: 3750Vac | | |
| | Isolation Resistance | I/P-O/P: 100MΩ/500VDC/25°C/70%RH | | |
| | Safety Standards | UL | America | UL8750 |
| | | CUL | Canada | CSA C22.2 NO. 250. 13 |
| | | CE | European Union | EN61347-1, EN61347-2-13, EN62384 |
| | EMC Emission | UL | America | FCC part 15 |
| | | CE | European Union | EN55015, EN61000-3-2, EN61000-3-3, EN61547 |
| EMC Immunity | EN61000-4-2,3,4,5,6,8,11, EN61547 | | | |
| Strobe Test Standard | IEEE 1789 | | | |
| OTHERS | Gross Weight(G.W) | 360g±10g | | |
| | Dimensions | 293×43×30mm(L×W×H) | | |
| | Package Size | 296×44×33mm(L×W×H) | | |
| | Outer Box Specifications | 315×230×215mm(L×W×H) 30pcs/ctn 11.6kg±5%/ctn | | |

The driver is suitable for connecting resistor current-limiting LED fixture (e.g. LED strip). The inrush current will be dozens of times increased if connecting built-in constant current IC current-limiting LED fixtures, the driver will activate the overloaded protection (hiccup flickering). When you order, please remark controlling the constant current LED fixture (e.g. MR16 lamp, underground light, LED wall washer, constant current LED strip, etc.), so that we can prepare them with special procedures.

Product Size

Unit: mm

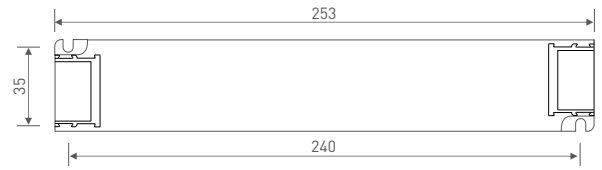
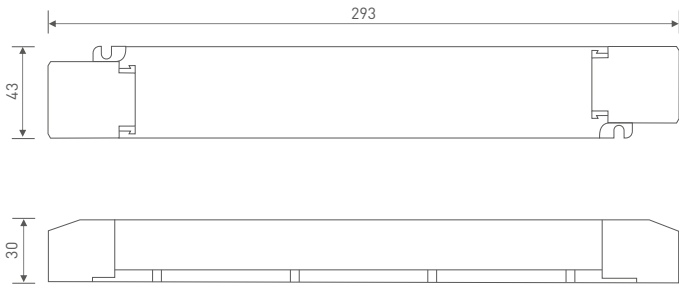

Wiring Diagram

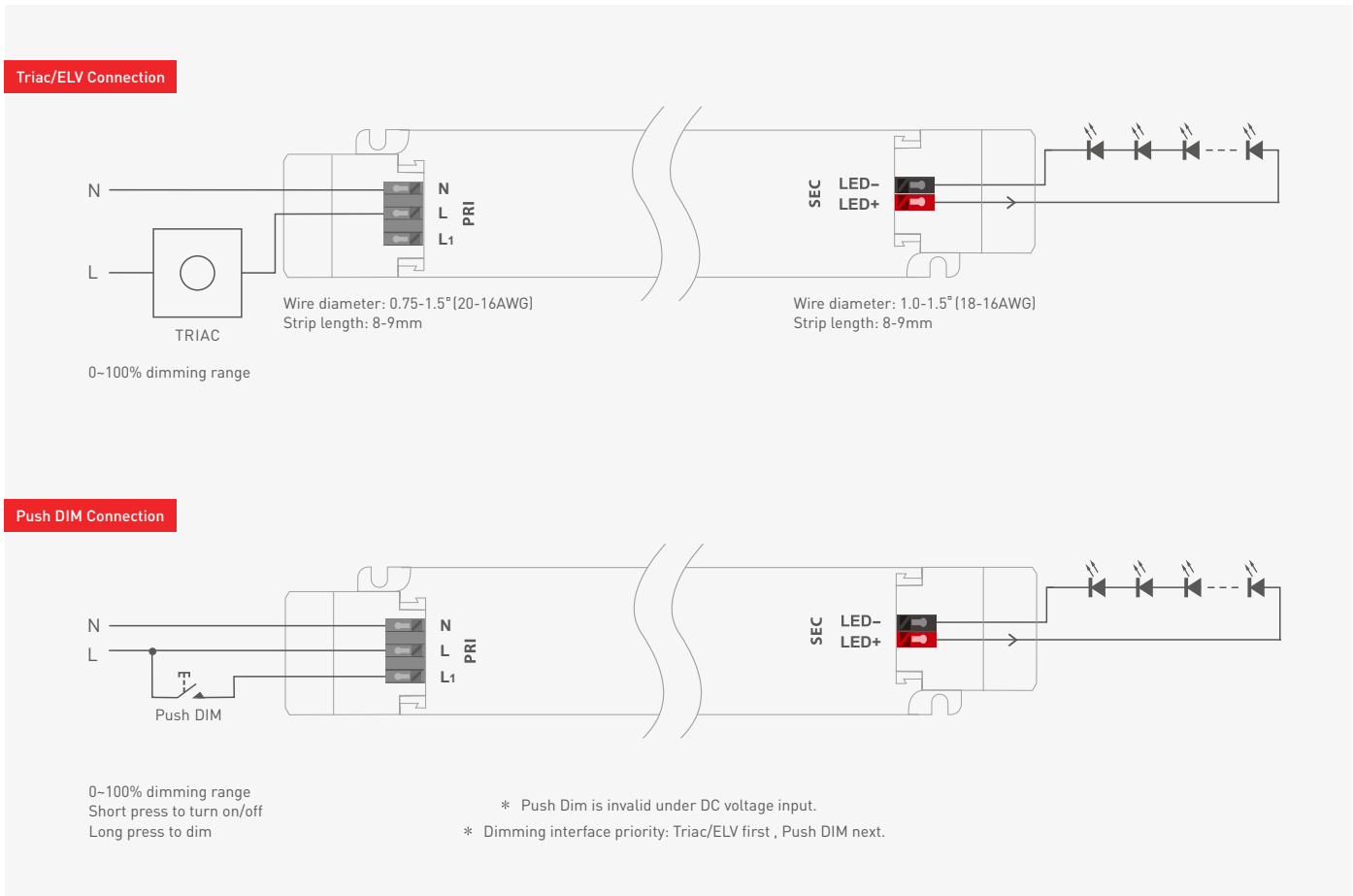

Push DIM

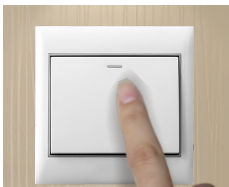

Reset switch

- On/off control: Short press.
- Stepless dimming: Long press.
- With every other long press, the brightness level goes to the opposite direction.
- Dimming memory: Dimming memory: Short press the PUSH DIM button, the brightness will go to the the previously adjusted level.
Power on again after power cut, the output brightness will be adjusted in accordance with the input voltage of drivers.

Protective Housing Application Diagram

Tension plate



1. Pry up the protecting housing in the side plate position with a tool.

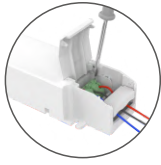

2. Connect to electrical wires with a screwdriver as wiring diagram shows.

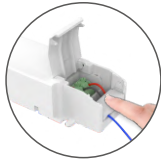

3. Press down the tension plate to fix the the electrical wires, then close the protective housing.

Remove the protective housing

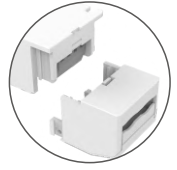
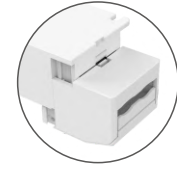

Pull the housing left and right from the bottom to remove it.

Installation Precautions

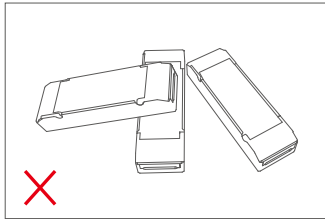

Please do not stack the products. The distance between two products should be $\geq 15\text{cm}$ so as not to affect heat dissipation and the lifespan of the products.

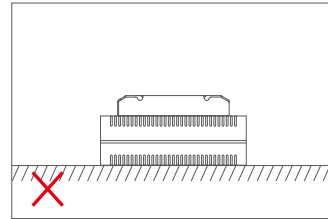
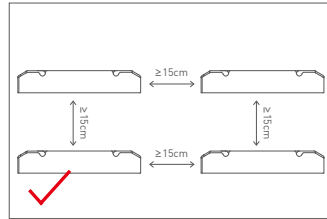

Please not place the products on LED drivers. The distance between the product and the driver should be $\geq 15\text{cm}$ so as not to affect heat dissipation and shorten the lifespan of the products.

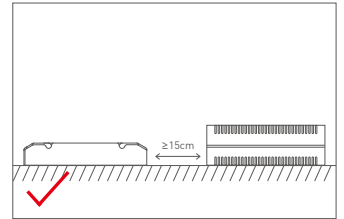

Relationship Diagrams

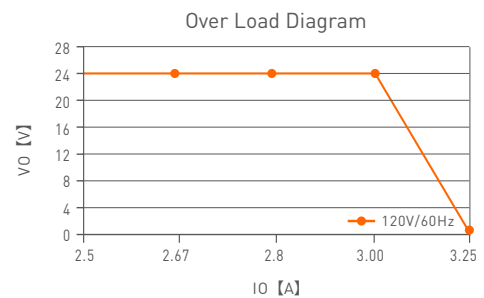
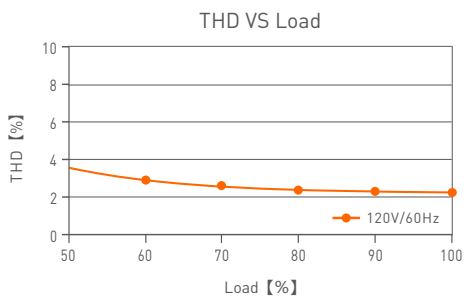
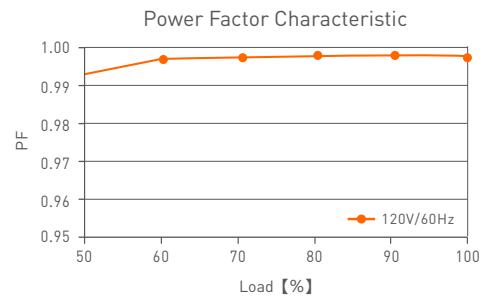
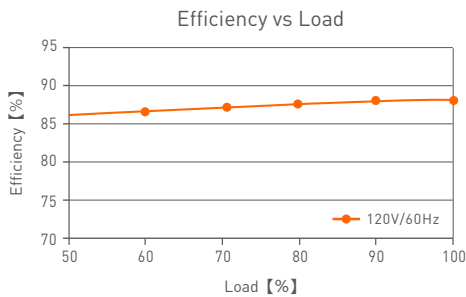

LM-60-24-L1T2

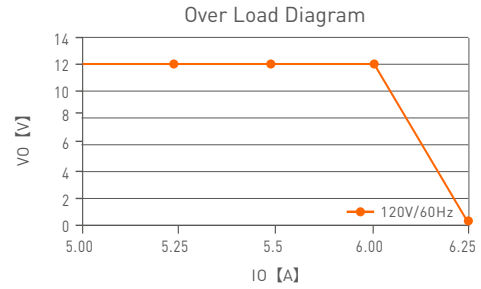
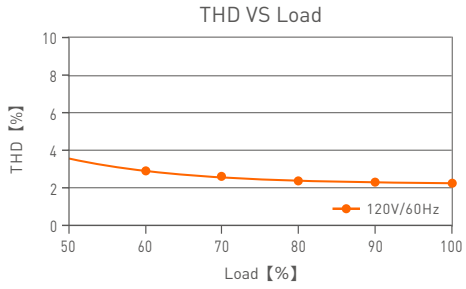
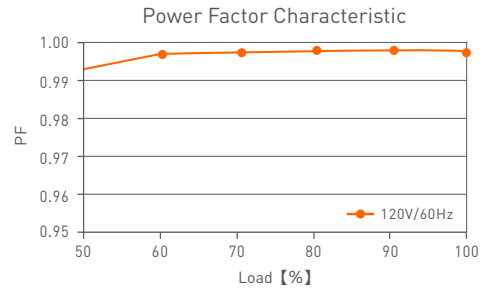
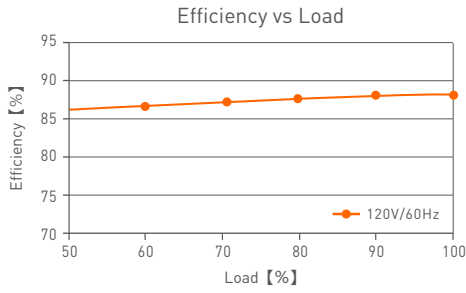

LM-60-12-L1T2

Flicker Test Table

| Limit Value of Modulation in Low Risk Areas | |
|--|---|
| Waveform frequency of Optical output (f) | Limit value (%) |
| $f \leq 8\text{Hz}$ | 0.2 |
| $8\text{Hz} < f \leq 90\text{Hz}$ | $0.025 \times f$ |
| $90\text{Hz} < f \leq 1250\text{Hz}$ | $0.08 \times f$ |
| $f > 1250\text{Hz}$ | Exemption assessment |
| Limit Value of Modulation in No Effect Areas | |
| Waveform frequency of Optical output (f) | Limit value (%) |
| $f \leq 10\text{Hz}$ | 0.1 |
| $10\text{Hz} < f \leq 90\text{Hz}$ | $0.01 \times f$ |
| $90\text{Hz} < f \leq 3125\text{Hz}$ | $[0.08/2.5] \times f$ |
| $f > 3125\text{Hz}$ | Exemption assessment (High frequency exemption) |

- Brightness
- ▲ 0.1%
 - ◆ 1%
 - ◆ 5%
 - ◆ 10%
 - 20%
 - ▲ 30%
 - 40%
 - ★ 50%
 - 60%
 - 70%
 - ◆ 80%
 - ★ 90%
 - ◆ 100%

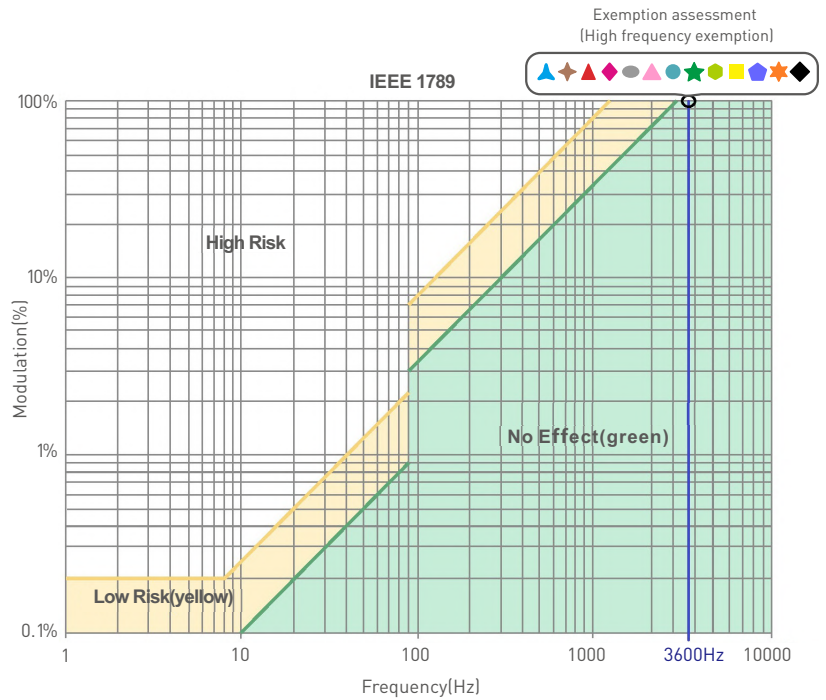

Marks in the right chart are tested results of different current levels. The output frequency is 0Hz in 100% brightness and its corresponding modulation is 0%, which could not be shown in the right chart.

Attentions

- Products shall be installed by qualified professionals.
- LTECH products are non-waterproof (special models excepted). Please avoid the sun and rain. When installed outdoors, please ensure it is mounted in a water proof enclosure.
- Good heat dissipation will extend the working life of products. Please ensure good ventilation.
- Please check if the working voltage used complies with the parameter requirements of products.
- The diameter of wire used must be able to load the light fixtures you connect and ensure the firm wiring.
- Before you power on products, please make sure all the wiring is correct in case of incorrect connection that causes damage to light fixtures.
- If a fault occurs, please do not attempt to fix products by yourself. If you have any question, please contact your suppliers.

* This manual is subject to changes without further notice. Product functions depend on the goods. Please feel free to contact our official distributors if you have any question.

Warranty Agreement

- Warranty periods from the date of delivery: 5 years.
- Free repair or replacement services for quality problems are provided within warranty periods.

Warranty exclusions below:

- Beyond warranty periods.
- Any artificial damage caused by high voltage, overload, or improper operations.
- Products with severe physical damage.
- Damage caused by natural disasters and force majeure.
- Warranty labels and barcodes have been damaged.
- No any contract signed by LTECH.

1. Repair or replacement provided is the only remedy for customers. LTECH is not liable for any incidental or consequential damage unless it is within the law.
2. LTECH has the right to amend or adjust the terms of this warranty, and release in written form shall prevail.

Update Log

| Version | Updated Time | Update Content | Updated by |
|---------|--------------|----------------------------|------------|
| A0 | 2021.03.29 | Original version | Liu Weili |
| A1 | 2021.12.10 | Update product silk screen | Liu Weili |