

LTECH

DMX/RDM Signal Amplifier



RDM-AMP-4E

RDM-AMP-8E

Product Features

- Used in the DMX/RDM lighting control system.
- Automatically recognize DMX/RDM signals.
- 1 channel input, 4/8 channel outputs; multiple channel outputs to increase DMX device number.
- Relay function for amplifying weak DMX/RDM signals and extending the signal transmission distance.
- BYPASS function for expanding DMX device number.
- Independent photoelectric isolation between the input and the outputs to improve overall security and reliability of the lighting control system.
- Neutrik 5-pin XLR connectors ensure security and reliability.
- Standard 1U rack-mounted signal amplifier. Be ready to use out of the rack mount cabinet.
- Used in TV broadcast lighting, stage lighting, entertainment venue lighting, etc.



Package Contents

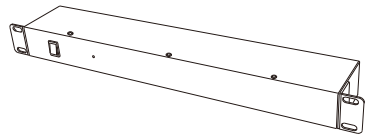

Signal amplifier ×1



KM3 screw ×4

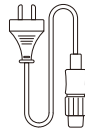

Aviation plug ×1

Technical Specs

Product model	RDM-AMP-8E	RDM-AMP-4E
Input voltage	100-240V~, 50/60Hz	
Input signal	1CH DMX/RDM signal input (photoelectric isolation>3KV)	
Output signal	8CH DMX/RDM signal input (photoelectric isolation>3KV) 1CH OUTPUT (BYPASS)	4CH DMX/RDM signal input (photoelectric isolation>3KV) 1CH OUTPUT (BYPASS)
Input port	5-pin XLR×1	
Output port	5-pin XLR×8	5-pin XLR×4
Working temperature	-20°C~55°C	
Dimensions	486×76×44mm(L×W×H)	
Package size	536×139×91mm(L×W×H)	
Net weight	1150g	

Product Size

Unit: mm

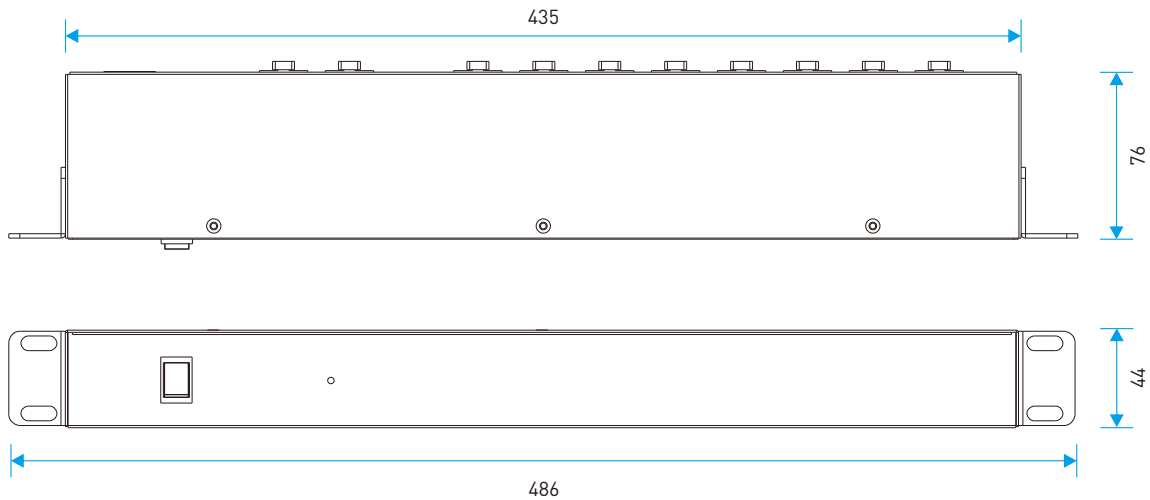

Overview

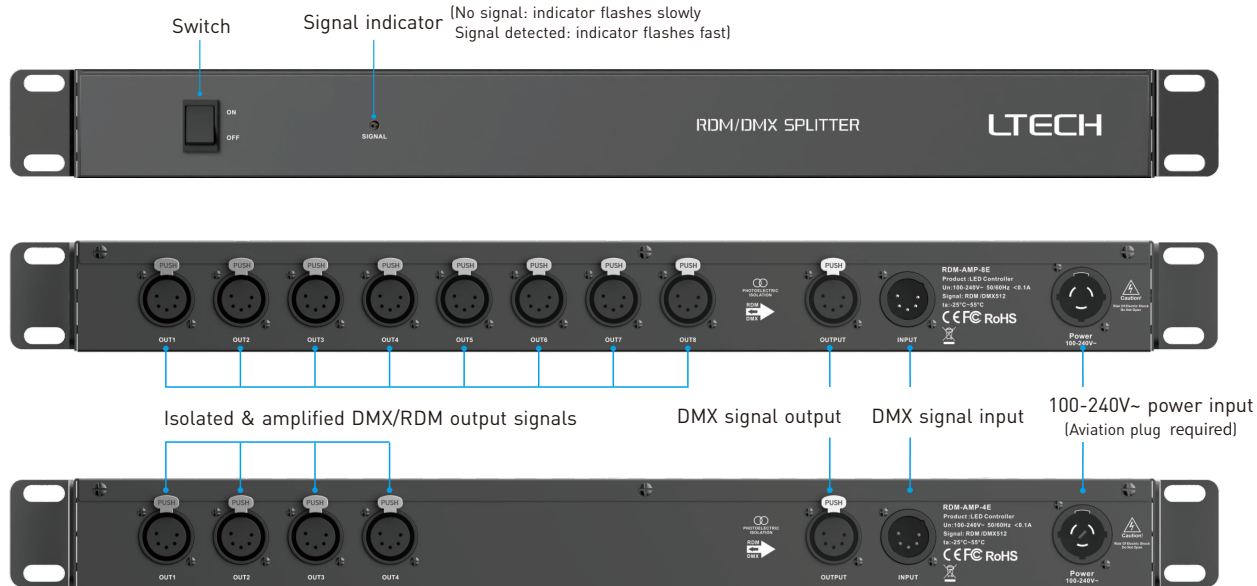

Power cord replacement diagram

This product includes a power cord. If it is not applicable, you can replace this power cord depending on your need.

- ① A 3-core 2.5mm cable is needed for the aviation plug.

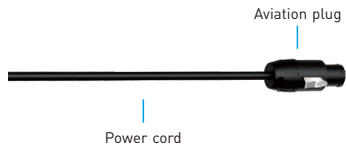

- ③ Use a screwdriver to unscrew the screws on the wire connector and remove the original power cord, then replace with a new one.



- ② Unscrew the anti loose nut and the waterproof silicone wire shell first, then push the wire connector out of the 3-core cold shrinkable copper terminal

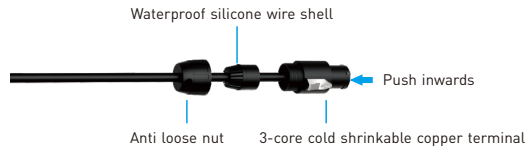

Note: Cable installation

The exposed cable wires need to be tinned. Then insert the cables deep down into the terminal block of the plug, and tighten the terminal screws. Please note that the wire clamp is used to fasten the cable, not the exposed wires.

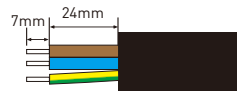

RDM-AMP-8E

Connection diagram of relay mode

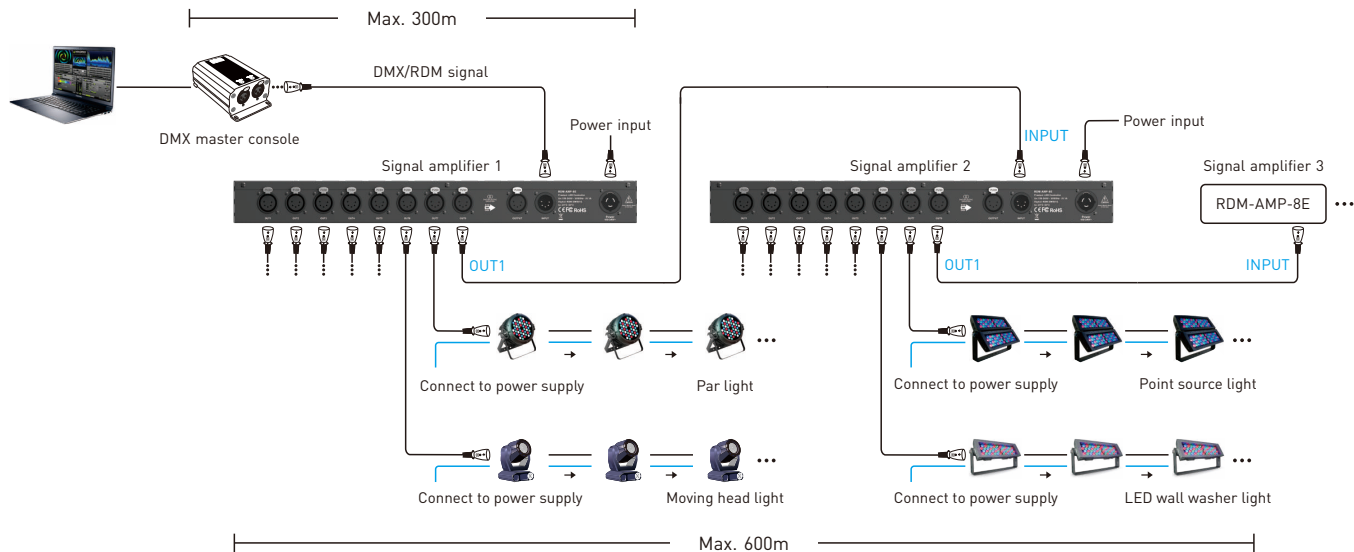

RDM-AMP-8E

Connection diagram of extended mode

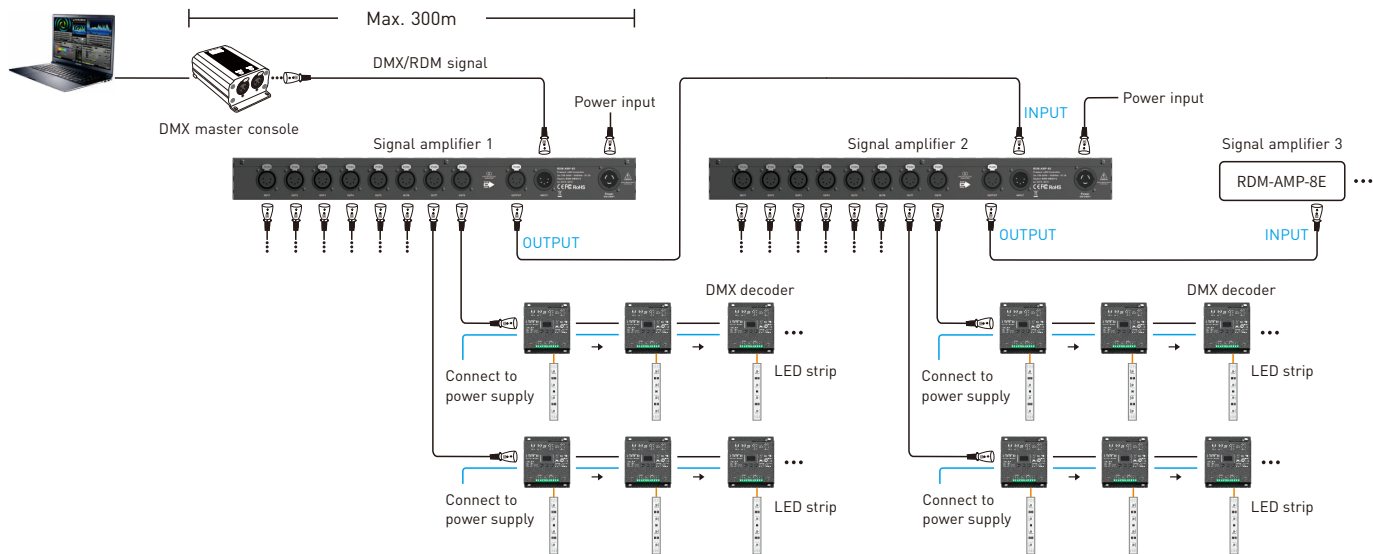

RDM-AMP-4E

Connection diagram of relay mode

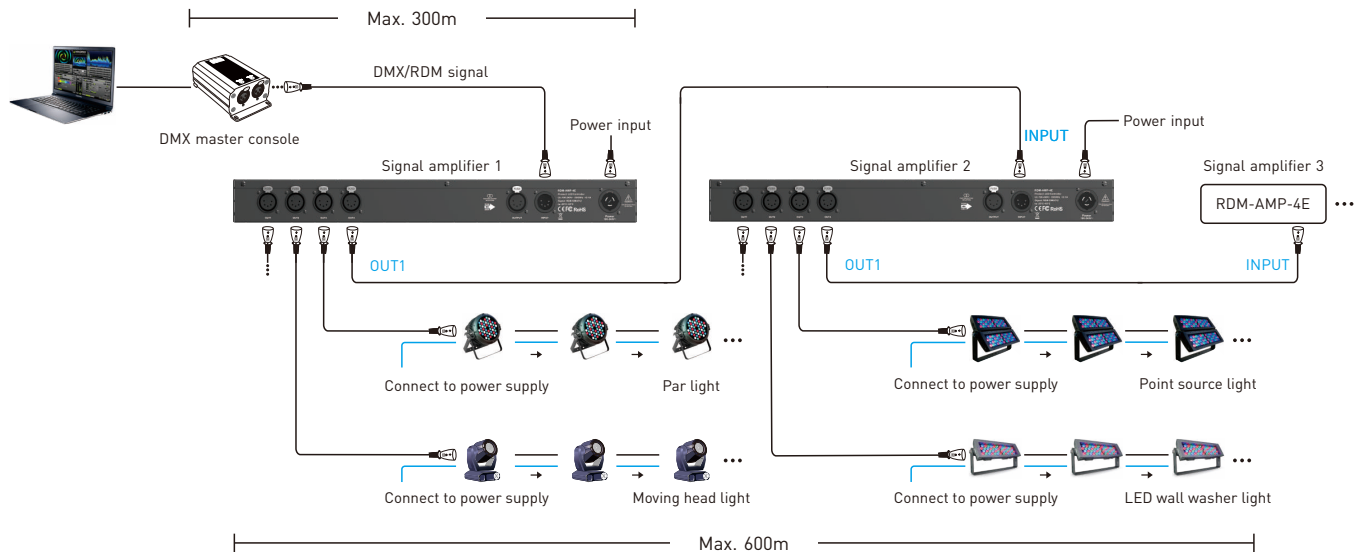

RDM-AMP-4E

Connection diagram of extended mode

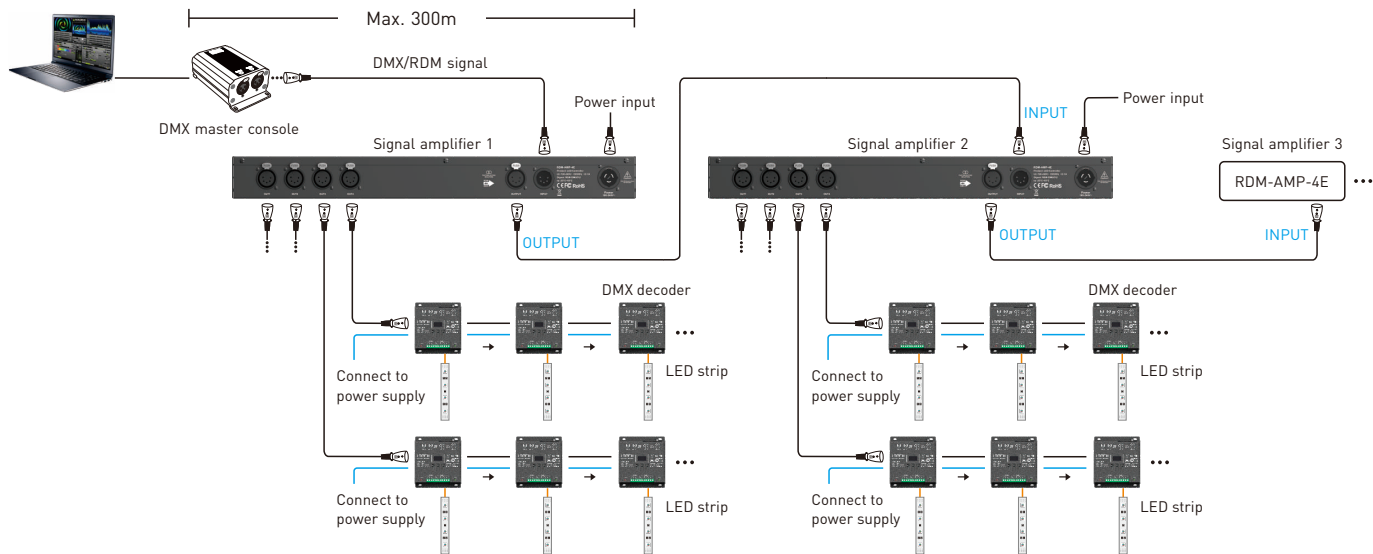

Work with a RDM Programmer

DMX/RDM signal amplifier can work with a RDM programmer that follows the standard RDM protocol.

It is recommended to use the LTECH RDM Programmer (Model: WiFi-RDM01), which allows users to remotely browse & set parameters, DMX address via the mobile APP.

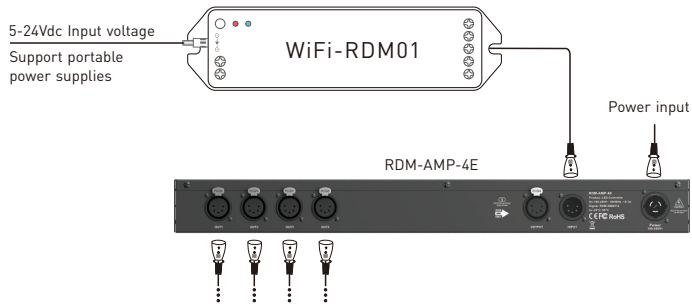
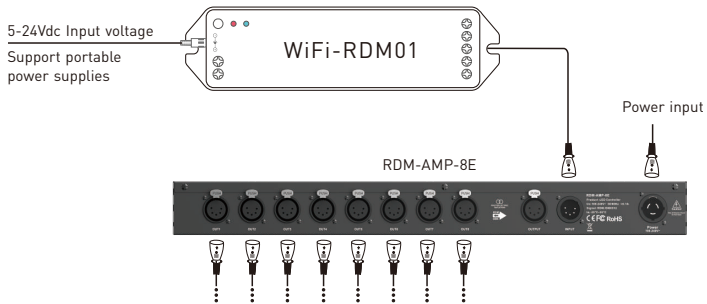

Mobile App Interfaces for the RDM Programmer

Download the App with your mobile phone and connect to the RDM Programmer successfully, then you are allowed to set parameters through the APP. Please refer to the WiFi-RDM01 manual for more details.

- At the homepage, click "Add" of the device you are going to edit the address, as shown below in the interface.
- Click "ID" to get more details for devices.
- Click "No" to issue a recognizing command.
- Click "⚙️" in the upper left corner to access the settings which allows you to test, edit DMX addresses, etc.

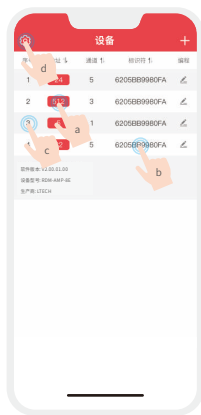

Home page

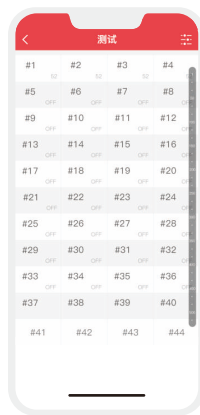

Test



DMX address setting

Transportation and Storage

1. Transportation

Products can be shipped via vehicles, boats and planes.

During transportation, products should be protected from rain and sun. Please avoid severe shock and vibration during the loading and unloading process.

2. Storage

The storage conditions should comply with the Class I Environmental Standards. The products that have been stored for more than six months are recommended to be re-inspected and can be used only after they have been qualified.

Attentions

- Product installation and commissioning should be done by a qualified professional.
- This product is non-waterproof (special models excepted). Please avoid the sun and rain. When installed outdoors, please ensure it is mounted in a water proof enclosure.
- Good heat dissipation will extend the life the product. Please install the product in a environment with good ventilation.
- Please check whether the working voltage used complies with the parameter requirements of the product.
- Before you power on the product, please make sure all the wiring is correct in case of incorrect connection that may cause a short circuit and damage the components, or trigger a accident.
- If a fault occurs, please do not attempt to fix the product by yourself. If you have any question, please contact the supplier.

Warranty Agreement

- Warranty periods from the date of delivery: 5 years.
- Free repair or replacement services for quality problems are provided within warranty periods.

Warranty exclusions below:

- Beyond warranty periods.
- Any artificial damage caused by high voltage, overload, or improper operations.
- Products with severe physical damage.
- Damage caused by natural disasters and force majeure.
- Warranty labels and barcodes have been damaged.
- No any contract signed by LTECH.

1. Repair or replacement provided is the only remedy for customers. LTECH is not liable for any incidental or consequential damage unless it is within the law.
2. LTECH has the right to amend or adjust the terms of this warranty, and release in written form shall prevail.

* This manual is subject to changes without further notice. Product functions depend on the goods. Please feel free to contact our official distributors if you have any question.

Update Time: 17/04/2024_A0

LTECH

DMX/RDM
信号放大分配器



RDM-AMP-4E

RDM-AMP-8E

产品介绍

- 自动识别DMX/RDM信号，用于DMX/RDM总线连接的灯光控制系统；
- 单进多出信号接口，可多路控制，增强DMX/RDM总线接入设备数量的能力；
- 具有中继功能，对DMX/RDM衰减信号进行整形放大处理，延长信号传输距离；
- 具有旁路BYPASS功能，扩展设备数量，满足灯光系统所需控制；
- 独立光电隔离保护，可故障现场隔离，提高灯光控制系统安全运行可靠性；
- 使用NEUTRIK五芯卡侬插头，质量安全更可靠；
- 标准1U机箱架构，方便安装在标准机柜中，无需改造，即装即用；
- 适用于电视台录播现场、舞台演出、娱乐场所等。



RoHS



包装清单

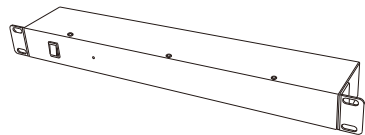

信号放大分配器 × 1



KM3螺丝 × 4

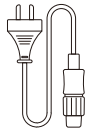

航空电源插头 × 1

技术参数

产品型号	RDM-AMP-8E	RDM-AMP-4E
输入电压	100-240V~, 50/60Hz	
输入信号	1路 DMX/RDM 信号输入 (光电隔离>3KV)	
输出信号	8路 DMX/RDM 信号输入 (光电隔离>3KV) 1路 OUTPUT (旁路 BYPASS) 输出	4路 DMX/RDM 信号输入 (光电隔离>3KV) 1路 OUTPUT (旁路 BYPASS) 输出
输入接口	5针XLR×1	
输出接口	5针XLR×8	5针XLR×4
工作温度	-20°C~55°C	
产品尺寸	486×76×44mm(L×W×H)	
包装尺寸	536×139×91mm(L×W×H)	
产品重量	1150g	

尺寸图

单位: mm

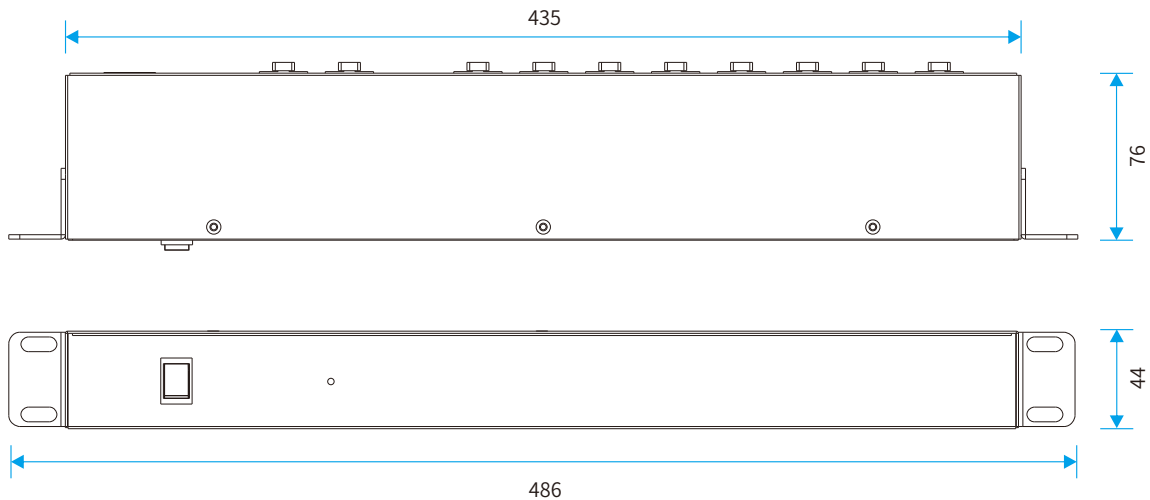

部件图

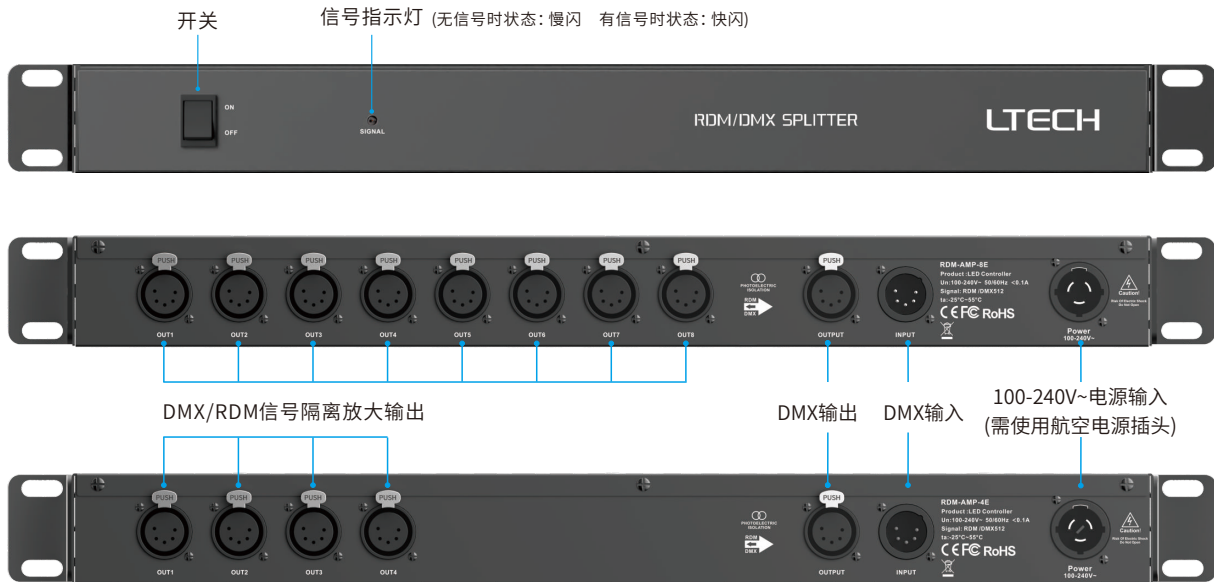

电源线更换示意图

本产品已配置电源线，如不适用，可根据需求更换电源线。

① 航空电源插头适用线规3*2.5平方电线。

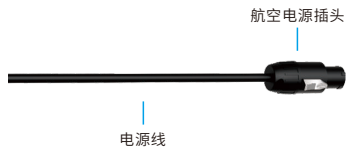

③ 在输出卡扣装置处用螺丝批拧开螺丝可将配置电源线拆卸，即可更换电源线。



② 将防松迫紧螺帽与进线防水硅胶爪拧出后，按压三芯冷压铜端子。



注：线缆安装

线缆剥线时拨出的导体需要进行上锡处理，在装入插头接线端子时，需完全插入端子底部方可拧紧螺丝；夹线套需夹持住线缆主体，不能直接夹在剥出的芯线上。

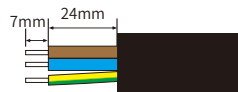

RDM-AMP-8E

中继模式连接示意图

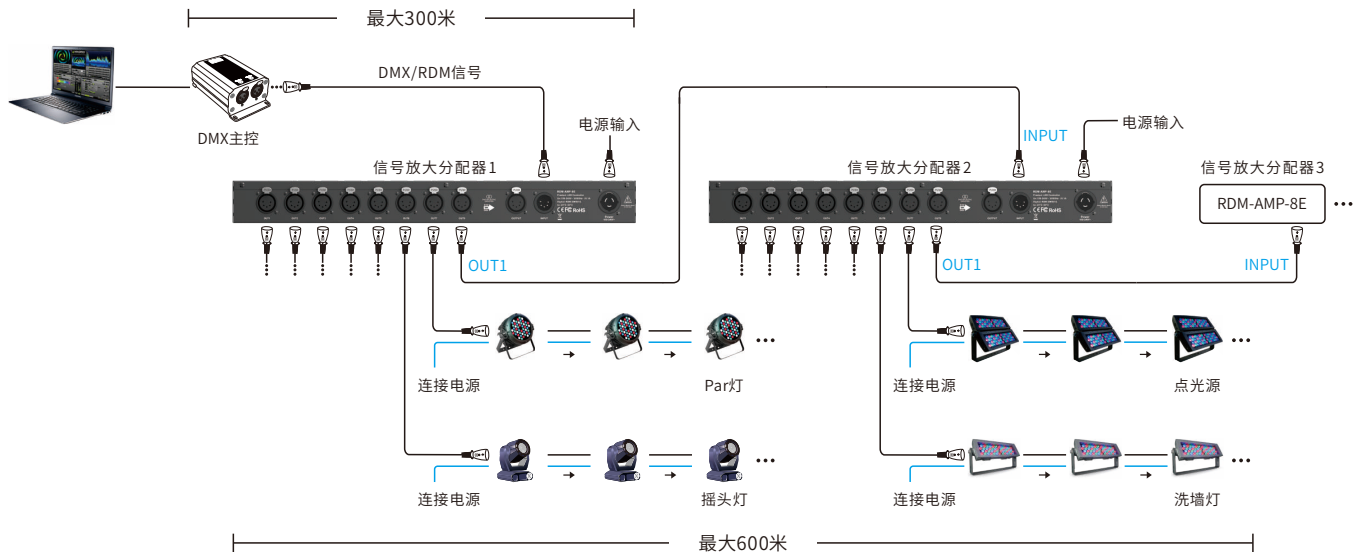

RDM-AMP-8E

扩展模式连接示意图

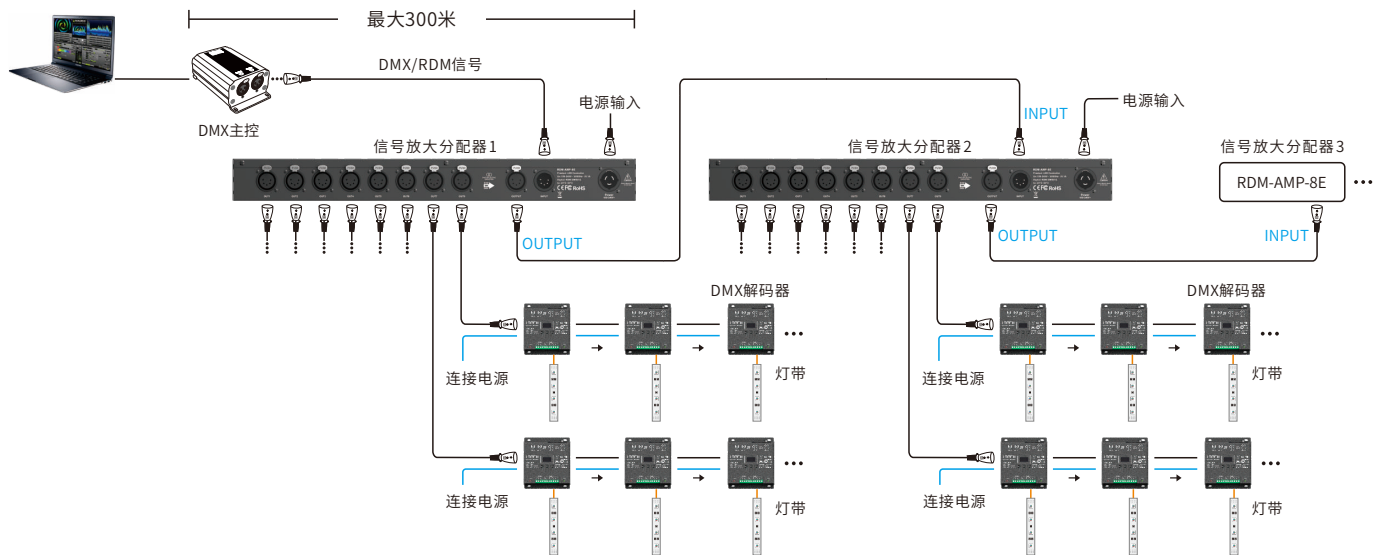

RDM-AMP-4E

中继模式连接示意图

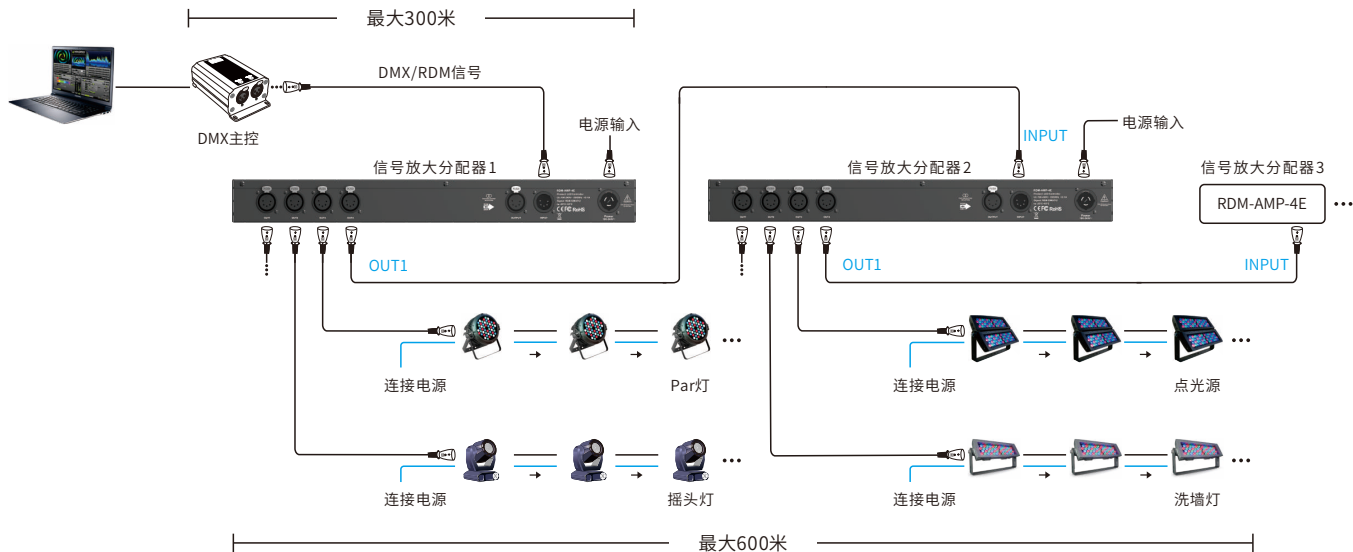

RDM-AMP-4E

扩展模式连接示意图

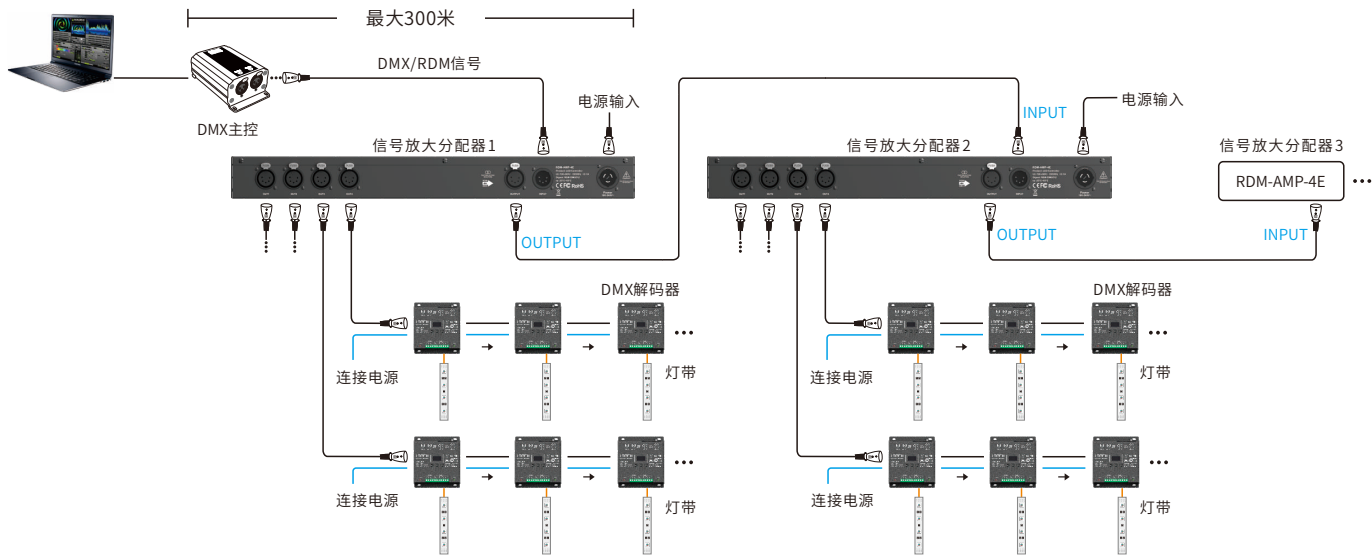

与RDM编辑器配合使用

DMX/RDM信号放大分配器可以与遵从标准RDM协议的地址编辑器配合使用。

建议使用LTECH的RDM编辑器(型号WiFi-RDM01), 可实现手机远程浏览与设置参数等更多功能, 连接图如下:

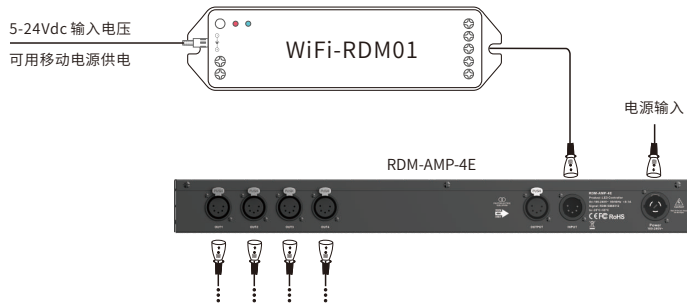
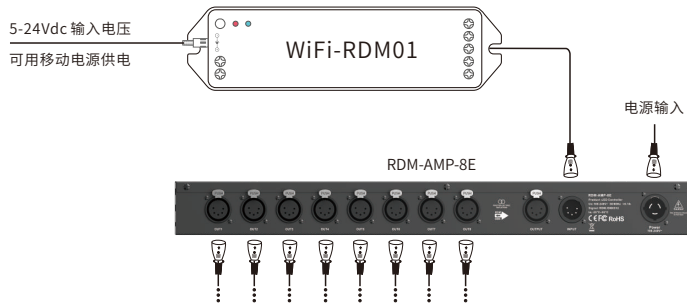

LTECH RDM编程器APP界面介绍

手机下载APP与RDM编辑器连接成功后，即可通过APP设置参数，具体请参看WiFi-RDM01的使用说明书。

- 在首页界面,点击对应设备的"地址"方框编辑设备地址;
- 点击"标识符"出现设备详细信息;
- 点击序号发出识别命令;
- 点击右上角设置""按钮,进入设置界面,可以进行测试、编写DMX地址等。

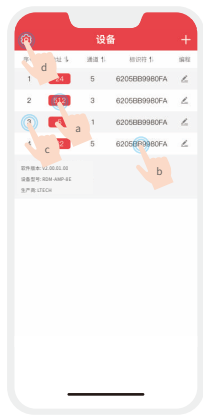

首页

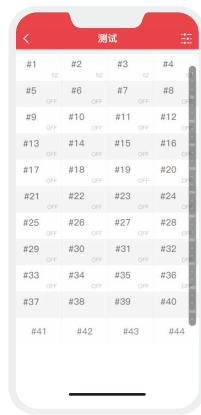

测试



DMX地址设置

运输和贮存

1.运输

产品适用车、船、飞机交通运输工具运输。

在运输中，应使用遮蓬进行防雨和防晒，并保持文明装卸，不应有剧烈振动、撞击等。

2.贮存

贮存符合I类环境的规定。贮存期限超过6个月的产品建议重新检验，合格后方可使用。

注意事项

- 请由具有专业资格的人员进行调试安装。
- 雷特产品（专有型号除外）不能防水，需避免日晒雨淋，如安装在户外，请用防水箱。
- 良好的散热条件会延长产品的使用寿命，请把产品安装在通风良好的环境。
- 请检查使用的工作电压是否符合产品的参数要求。
- 通电调试前，应确保所有接线正确，以避免因接线错误而导致产品损坏。
- 如果发生故障，请勿私自维修；如有疑问，请联系供应商。

* 本说明书的内容如有变更，恕不另行通知。若内容与您使用的功能有所不同，则以实物为准。如有疑问，请与供应商联系。

保修条例

- 自出厂之日起保修服务期为5年。
- 在保修服务期内出现产品质量问题雷特将给予免费修理或更换服务。

非保修条例：

属下列情况不在免费保修或更换服务范围之内：

- 已经超出保修服务期；
- 过高电压、超负载、操作不当等人为造成的损坏；
- 产品外形严重损坏或变形；
- 自然灾害以及人力不可抗拒原因造成的损坏；
- 产品保修标签和产品唯一条形码损坏；
- 无雷特签订的合同或发票凭证。

1. 修理或更换是雷特对客户唯一补救措施。雷特不承担任何附带引起的损害赔偿，除非在适用法律范围之内。
2. 雷特享有修正或调整本保修条款的权利，并以书面形式发布为准。
