

Intelligent LED Driver (Constant Current)

- Housing made from SAMSUNG/COVESTRO's V0 flame retardant PC materials.
- Ultra small, thin and lightweight, screwless end cap.
- DALI bus standard IEC62386-101, 102, 207.
- Class 2 LED driver, Safety Extra Low Voltage (SELV).
- Soft-on and fade-in dimming function enhances your visual comfort.
- T-PWM™ dimming technology allows quality and high-end lighting.
- The whole dimming process is flicker-free with high frequency exemption level.
- Multiple current levels, wide voltage range, suitable for LEDs with different power
- Comply with the EU's ErP Directive, networked standby<0.5W.
- When there is no load, the output will be 0V to prevent damage to LEDs due to poor contact.
- Overheat, over voltage, overload, short circuit protection and automatic recovery.
- Suitable for Class I / II / III indoor light fixtures.
- Normal service life can reach 100,000 hours.
- 5-year warranty (Rubycon capacitor).



Flicker Free
IEEE 1789

Dimmable:
10000:1



The certification icon represents undergoing certification applications only, and final certification qualification subject to actual product.

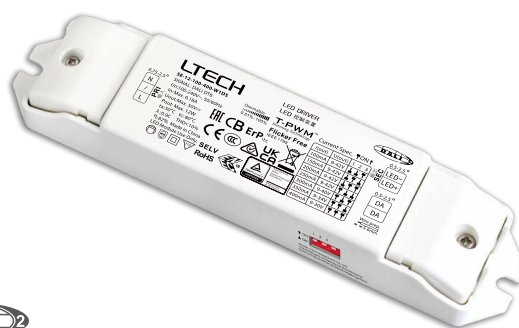

Technical Specs

Model	SE-10-350-700-W1DS	SE-12-100-400-W1DS	SE-12-350-700-W1DS		
Features	Output Type	Constant current			
	Dimming Interface	DALI DT6			
	Output Feature	Isolation			
	Protection Grade	IP20			
	Insulation Grade	Class II (Suitable for class I/ II /III light fixtures)			
OUTPUT	Output Voltage	2-12Vdc	9-42Vdc	9-24Vdc	
	Output voltage range(No-load)	≤35Vdc	≤50Vdc	≤35Vdc	
	Output Current Range	350-700mA	100-400mA	350-700mA	
	Load power range	0.7W-8.4W	0.9W-12W	3.15W-12W	
	Dimming Range	0-100%, down to 0.01%			
	LF Current Ripple	<3%(Maximum current for non dimming state)			
	Current Accuracy	±5%			
	PWM Frequency	≤3600Hz			
INPUT	DC Voltage Range	120-300Vdc			
	AC Voltage Range	100-240Vac			
	Input Voltage	115Vac/230Vac			
	Frequency	50/60Hz			
	Input Current	≤0.15A/115Vac (at full load), ≤0.07A/230Vac (at full load),	≤0.18A/115Vac (at full load), ≤0.08A/230Vac (at full load),	≤0.18A/115Vac (at full load), ≤0.08A/230Vac (at full load),	
	Power Factor	PF>0.95/115Vac (at full load), PF>0.9C/230Vac (at full load),			
	THD	THD<10%/230Vac (at full load),			
	Efficiency (Typ.)	75% (at full load),	82% (at full load),	82%(at full load),	
	Inrush Current	Cold start 15A[Test twidth=102us tested under 50% Ipeak]/230Vac			
	Anti Surge	L-N:2KV			
Leakage Current	Max.0.24mA				
ENVIRONMENT	Working Temperature	ta:-20-50°C tc:80°C			
	Working Humidity	20 ~ 95%RH, non-condensing			
	Storage Temperature/Humidity	-40-80°C/10-95%RH			
	Temperature Coefficient	±0.03%/°C(-20°C-40°C)			
	Vibration	10-500Hz, 2G 12min/1cycle, 72 min for X, Y and Z axes respectively			
PROTECTION	Overload Protection	Automatically protect the device when the load exceeds 102% of the rated power. Automatically recover once load is reduced			
	Overheat Protection	Intelligently adjust or turn off the current output if the PCB temperature >110°C. When the PCB temperature <90°C, automatically recover normal output			
	Overvoltage Protection	Automatically protect the device when voltage exceeds the no-load voltage. It can be recovered automatically			
	Short Circuit Protection	Enter hiccup mode if short circuit occurs, and recover automatically			
SAFETY & EMC	Withstand Voltage	I/P-O/P: 3750Vac			
	Insulation Resistance	I/P-O/P: 100MΩ/500VDC/25°C/70%RH			
	Safety Standards	CCC	China	GB19510.1, GB19510.14	
		TUV	Germany	EN61347-1, EN61347-2-13, EN62493	
		CB	CB Member States	IEC61347-1, IEC61347-2-13	
		CE	European Union	EN61347-1, EN61347-2-13, EN62384	
		KC	Korea	KC61347-1, KC61347-2-13	
		EAC	Russia	IEC61347-1, IEC61347-2-13	
		RCM	Australia	AS 61347-1, AS 61347-2-13	
		ENEC	Europe	EN61347-1, EN61347-2-13, EN62384	
	EMC Emission	UKCA	Britain	BS EN 61347-1 BS EN 61347-2-13 BS EN 62493	
		BIS	India	IS 15885 (PART 2/SEC 13)	
		CCC	China	GB/T17743, GB17625.1	
		CE	European Union	EN55015, EN61000-3-2, EN61000-3-3, EN61547	
		KC	Korea	KSC 9815, KSC 9547	
EAC		Russia	IEC62493, IEC61547, EH55015		
RCM		Australia	EN55015, EN61000-3-2, EN61000-3-3, EN61547		
UKCA	Britain	BS EN IEC 55015 BS EN IEC 61000-3-2 BS EN 61000-3-3 BS EN 61547			
EMC Immunity	EN61000-4-2,3,4,5,6,8,11,EN61547				
ErP	Power Consumption	Standby power consumption	No standby mode		
		Networked standby	<0.5W (After shutdown by command)		
	Flicker/Stroboscopic Effect	No-load power consumption	<0.5W (When the lamp is not connected)		
		CIESVM	PstLM<1.0 SVM<0.4		
DF	Phase factor	DF>0.9			
OTHERS	Weight(N.W.)	80g±10g			
	Dimensions	135×30×20mm(L×W×H)			



LED Current Selection

DIP switch quickly selects 8th gear current value

SE-10-350-700-W1DS	DIP Switch									 ON OFF
	Output Current	350mA	400mA	450mA	500mA	550mA	600mA	650mA	700mA	
	Output Voltage	2-12V	2-12V	2-12V	2-12V	2-10V	2-12V	2-12V	2-12V	
	Output Power	0.7-4.2W	0.8-4.8W	0.9-5.4W	1-6W	1.1-6.6W	1.2-7.2W	1.3-7.8W	1.4-8.4W	

SE-12-100-400-W1DS	DIP Switch									 ON OFF
	Output Current	100mA	150mA	200mA	250mA	300mA	350mA	400mA		
	Output Voltage	9-42V	9-42V	9-42V	9-42V	9-40V	9-34V	9-30V		
	Output Power	0.9-4.2W	1.35-6.3W	1.8-8.4W	2.25-10.5W	2.7-12W	3.15-11.9W	3.6-12W		

SE-12-350-700-W1DS	DIP Switch									 ON OFF
	Output Current	350mA	400mA	450mA	500mA	550mA	600mA	650mA	700mA	
	Output Voltage	9-24V	9-24V	9-24V	9-24V	9-22V	9-20V	9-18.5V	9-17V	
	Output Power	3.15-8.4W	3.6-9.6W	4.05-10.8W	4.5-12W	4.95-12.1W	5.4-12W	5.85-12W	6.3-11.9W	

- * Before setting the current via the DIP switches, confirm that the LED driver is powered off. To make the current setting effective, you need to power on the driver again.
[Note: If you do not power off the driver before setting the current, it may cause damage to the light fixture.]
- * E.g. LED 3V/pcs: 9-42V can power 3-14pcs LEDs in series, 9-21.5V can power 3-7pcs LEDs, the max quantity of LEDs in series will be subject to the actual voltage of LED.

Product Size

Unit: mm

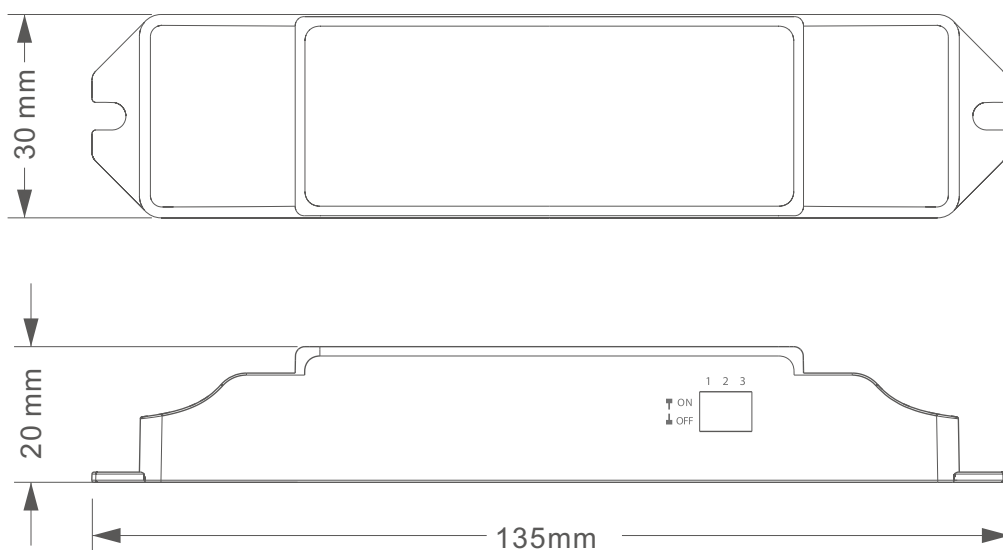

Wiring Diagram

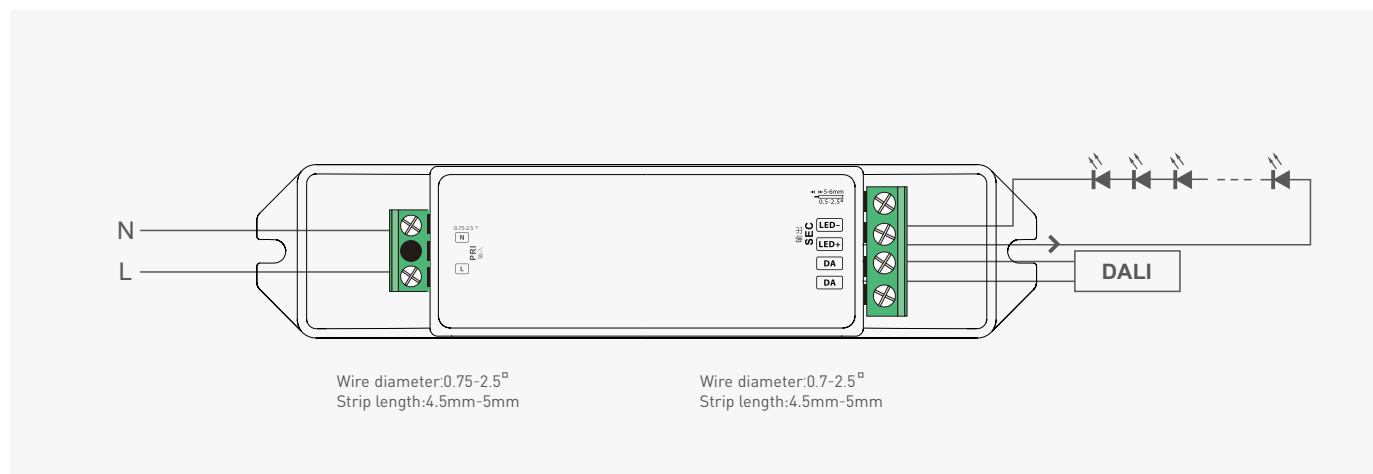

Relationship Diagrams

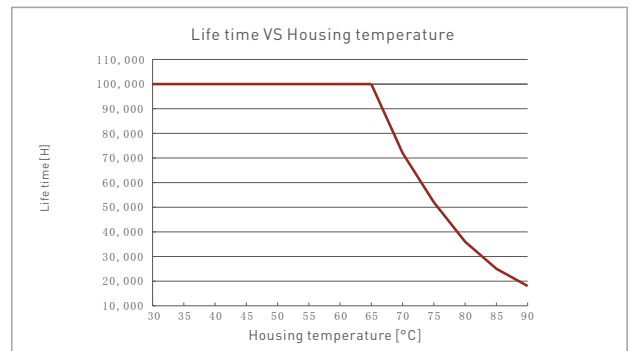
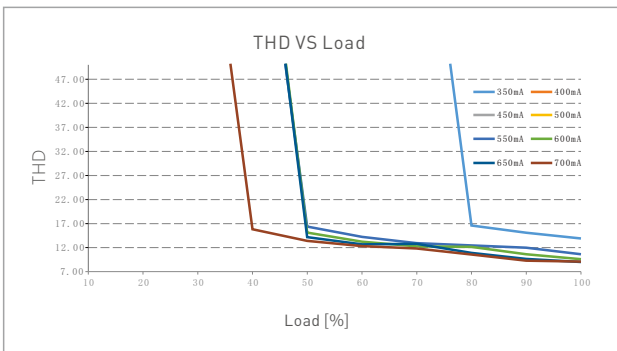
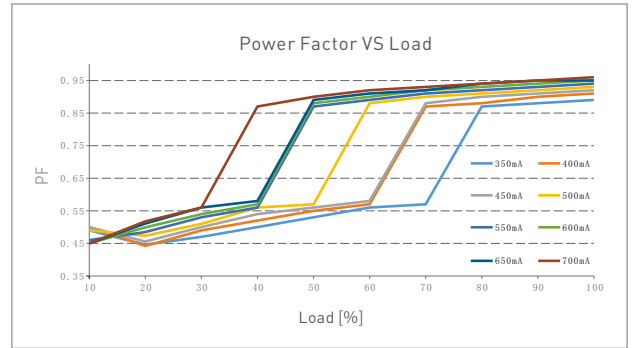
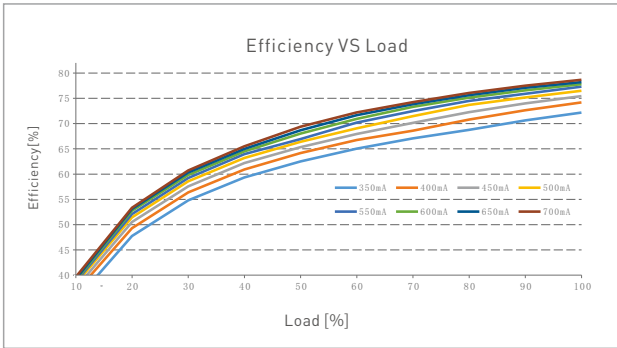

SE-10-350-700-W1DS

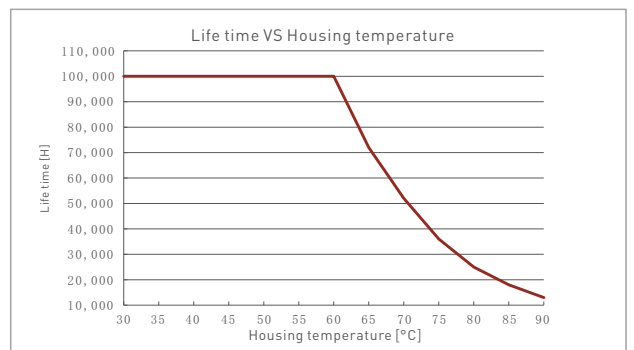
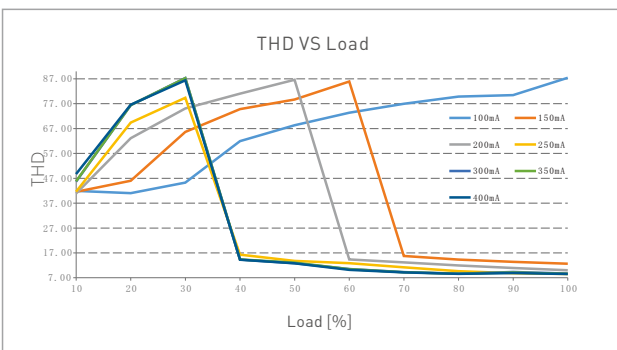
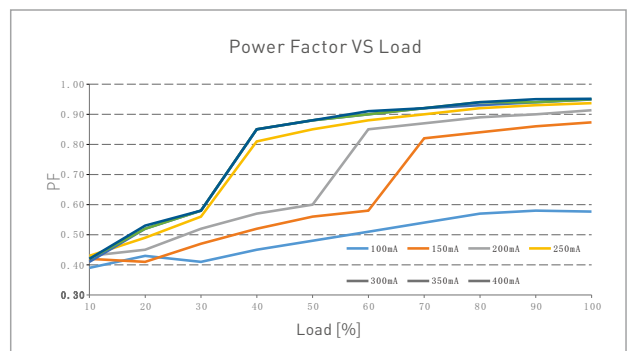
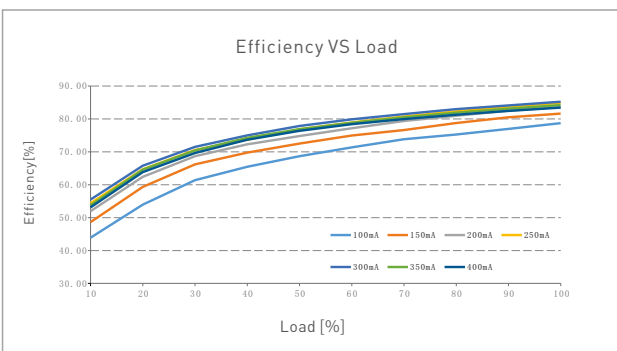

SE-12-100-400-W1DS

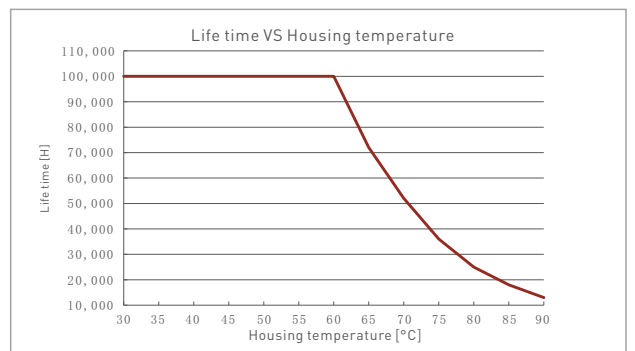
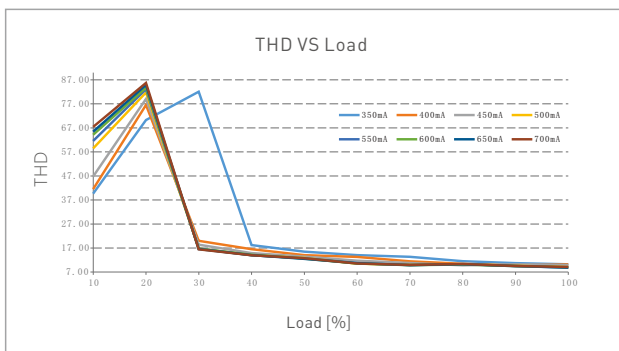
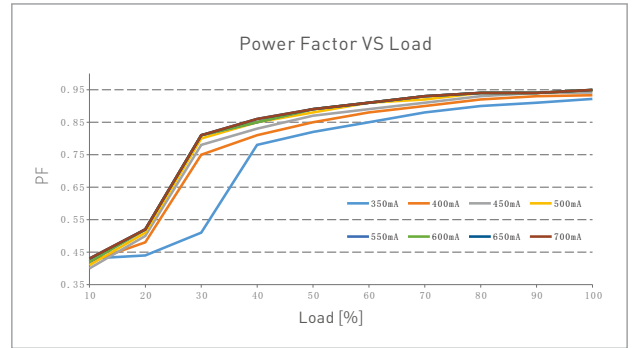
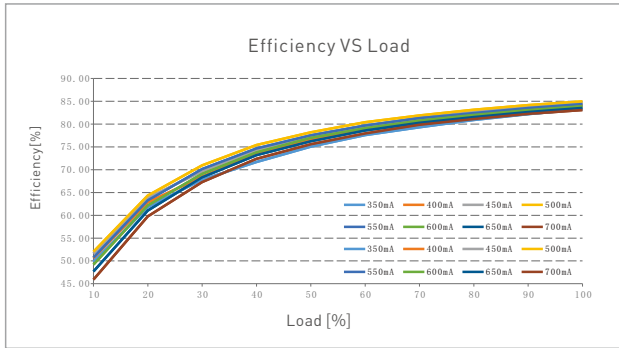

SE-12-350-700-W1DS

Flicker Test Sheet

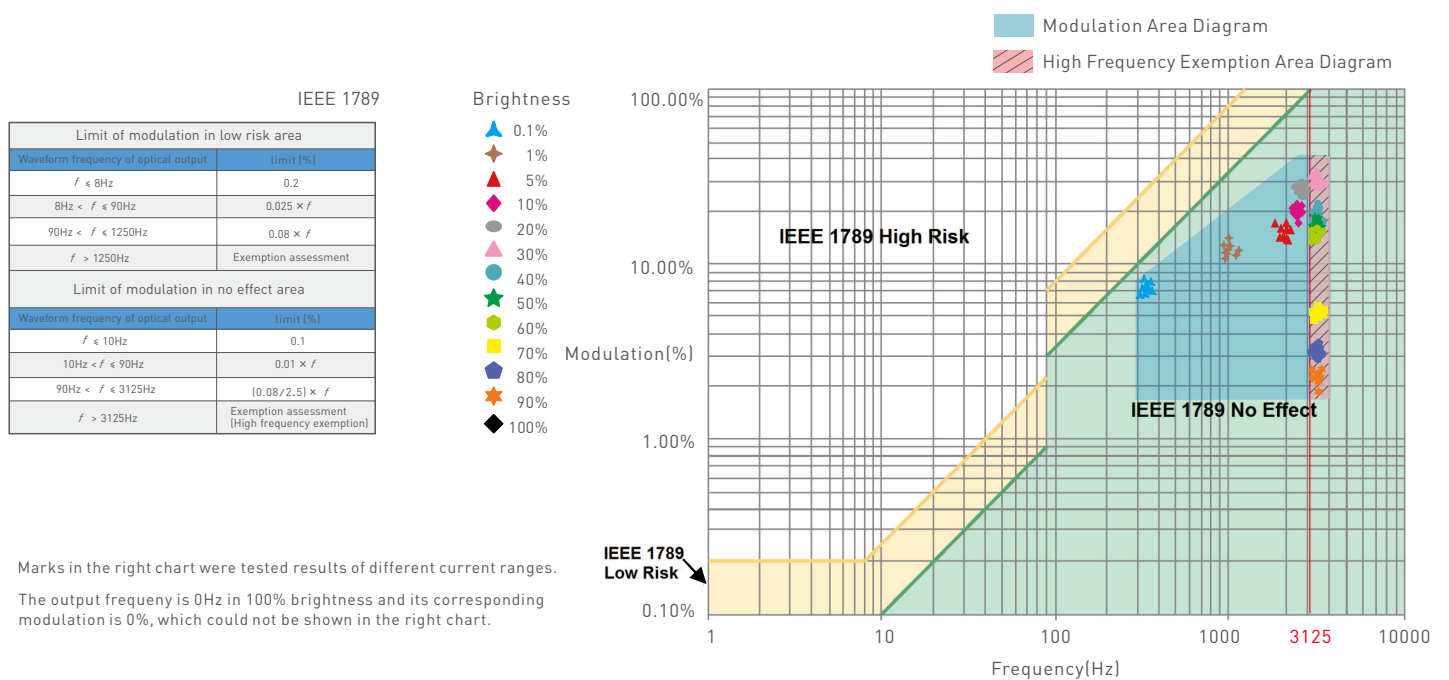

Packaging Specifications

Model	SE-10-350-700-W1DS/SE-12-100-400-W1DS/SE-12-350-700-W1DS
Carton Dimensions	350×285×180mm(L×W×H)
Quantity	30 PCS/Layer; 5 Layers/Carton; 150 PCS/Carton
Weight	0.08 kg/PC; 12 kg±5%/Carton

Packaging Image



Inner Packaging Box



Carton Packaging

Transportation and Storage

1. Transportation

Products can be shipped via vehicles, boats and planes.

During transportation, products should be protected from rain and sun. Please avoid severe shock and vibration during the loading and unloading process.

2. Storage

The storage conditions should comply with the Class I Environmental Standards. The products that have been stored for more than six months are recommended to be re-inspected and can be used only after they have been qualified.

Attentions

- This product must be installed and adjusted by a qualified professional.
- This product is non-waterproof (special models excepted). Please avoid the sun and rain. When installed outdoors, please ensure it is mounted in a water proof enclosure.
- Good heat dissipation will extend the life the product. Please install the product in a environment with good ventilation.
- When you install this product, please avoid being near a large area of metal objects or stacking them to prevent signal interference.
- Please keep the product away from a intense magnetic field, a high pressure area or a place where lightning is easy to occur.
- Please check whether the working voltage used complies with the parameter requirements of the product.
- Before you power on the product, please make sure all the wiring is correct in case of incorrect connection that may cause a short circuit and damage the components, or trigger a accident.
- If a fault occurs, please do not attempt to fix the product by yourself. If you have any question, please contact the supplier.

* This manual is subject to changes without further notice. Product functions depend on the goods. Please feel free to contact our official distributors if you have any question.

Warranty Agreement

- Warranty periods from the date of delivery: 5 years.
- Free repair or replacement services for quality problems are provided within warranty periods.

Warranty exclusions below:

- Beyond warranty periods.
- Any artificial damage caused by high voltage, overload, or improper operations.
- Products with severe physical damage.
- Damage caused by natural disasters and force majeure.
- Warranty labels and barcodes have been damaged.
- No any contract signed by LTECH.

1. Repair or replacement provided is the only remedy for customers. LTECH is not liable for any incidental or consequential damage unless it is within the law.
2. LTECH has the right to amend or adjust the terms of this warranty, and release in written form shall prevail.

Update Log

Version	Updated Time	Update Content	Updated by
A0	20230303	Original version	Yang Weiling