

Intelligent Tunable White LED Driver (Constant Current)

- Housing made from SAMSUNG/COVESTRO's V0 flame retardant PC materials.
- Ultra small, thin and lightweight, screwless end cap.
- Change the output current, dimming mode and other parameters via the APP.
- Adjustable output current with 1mA step.
- Automatically recognize 0-10V and 1-10V input signal.
- Ultra-low consumption of 0-10V ports < 0.05mA.
- Soft-on and fade-in dimming function enhances your visual comfort.
- T-PWM™ super deep dimming technology, 0.01% dimming depth.
- The whole dimming process is flicker-free with high frequency exemption level.
- Comply with the EU's ErP Directive, networked standby<0.5W.
- When there is no load, the output will be 0V to prevent damage to LEDs due to poor contact.
- Overheat, over voltage, overload, short circuit protection and automatic recovery.
- Suitable for Class I / II / III indoor light fixtures.
- Normal service life can reach 100,000 hours.
- 5-year warranty (Rubycon capacitor).

4 in 1 dimming
0-10V
1-10V
10V PWM
RX



T-PWM™
Dimming Technology

Flicker Free
IEEE 1789

Dimmable:
10000 : 1

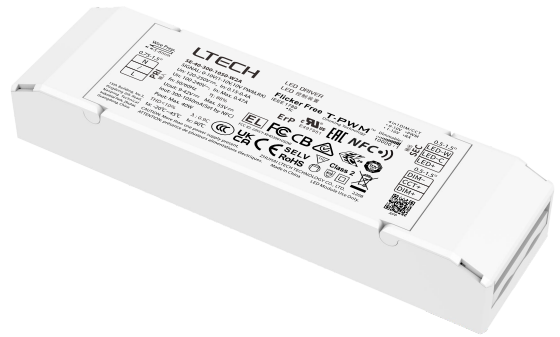

The certification icon represents undergoing certification applications only, and final certification qualification subject to actual product.



Technical Specs

| Model | | SE-40-300-1050-W2A | SE-30-200-800-W2A | |
|-----------------|-----------------------------------|--|--|--|
| Features | Output Type | Constant current | | |
| | Dimming Interface | 0-10V (1-10V, 10V PWM, RX) | | |
| | Output Feature | Isolation | | |
| | Protection Grade | IP20 | | |
| | Insulation Grade | Class II (Suitable for class I/ II /III light fixtures) | | |
| OUTPUT | Output Voltage | 9-42Vdc | | |
| | Maximum output voltage | ≤55Vdc | | |
| | Output Current Range | 300-1050mA | 200-800mA | |
| | Output Power Range | 2.7W-40W | 1.8W-30W | |
| | Dimming Range | 0-100%, down to 0.01% | | |
| | LF Current Ripple | <3%(Maximum current for non dimming state) | | |
| | Current Accuracy | ±5% | | |
| | PWM Frequency | ≤3600Hz | | |
| INPUT | DC Voltage Range | 120-250Vdc | | |
| | AC Voltage Range | 100-240Vac | | |
| | EoFi | 100% | | |
| | Input Voltage | 115Vac/230Vac | | |
| | Frequency | 50/60Hz | | |
| | Input Current | ≤0.45A/115Vac, ≤0.22A/230Vac | ≤0.34A/115Vac, ≤0.17A/230Vac | |
| | Power Factor | PF>0.95/115Vac (at full load), PF>0.9C/230Vac (at full load) | | |
| | THD | THD≤10%/230Vac, at full load | | |
| | Efficiency (Typ.) | 88% | 87% | |
| | Inrush Current | Cold start 25A(Test twidth=130us tested under 50% Ipeak)/230Vac | | |
| | Anti Surge | L-N: 2KV | | |
| Leakage Current | Max. 0.5mA | | | |
| ENVIRONMENT | Working Temperature | ta: -20 ~ 45°C tc: 90°C | | |
| | Working Humidity | 20 ~ 95%RH, non-condensing | | |
| | Storage Temperature/Humidity | -40 ~ 80°C/10-95%RH | | |
| | Temperature Coefficient | ±0.03%/°C(0-50°C) | | |
| | Vibration | 10-500Hz, 2G 12min/1cycle, 72 min for X, Y and Z axes respectively | | |
| PROTECTION | Overload Protection | Automatically protect the device when the load exceeds 102% of the rated power. Automatically recover once load is reduced | | |
| | Overheat Protection | Intelligently adjust or turn off the current output if the PCB temperature ≥110°C. When the PCB temperature <90°C, automatically recover normal output | | |
| | Overvoltage Protection | Automatically protect the device when voltage exceeds the no-load voltage. It can be recovered automatically | | |
| | Short Circuit Protection | Enter hiccup mode if short circuit occurs, and recover automatically | | |
| SAFETY & EMC | Withstand Voltage | I/P-O/P: 3750Vac | | |
| | Insulation Resistance | I/P-O/P: 100MΩ/500VDC/25°C/70%RH | | |
| | Safety Standards | CCC | China | GB19510.1, GB19510.14 |
| | | TUV | Germany | EN61347-1, EN61347-2-13, EN62493 |
| | | CB | CB Member States | IEC61347-1, IEC61347-2-13 |
| | | CE | European Union | EN61347-1, EN61347-2-13, EN62384 |
| | | KC | Korea | KC61347-1, KC61347-2-13 |
| | | EAC | Russia | IEC61347-1, IEC61347-2-13 |
| | | RCM | Australia | AS 61347-1, AS 61347-2-13 |
| | | ENEC | Europe | EN61347-1, EN61347-2-13, EN62384 |
| | | UKCA | Britain | BS EN 61347-1, BS EN 61347-2-13, BS EN 62493 |
| | | BIS | India | IS 15885 (PART 2/SEC 13) |
| | CUL | Canada | CSA C22.2 NO.250.13 | |
| | UL | America | UL 8750 | |
| | EMC Emission | CCC | China | GB/T17743, GB17625.1 |
| | | CE | European Union | EN55015, EN61000-3-2, EN61000-3-3, EN61547 |
| | | KC | Korea | KSC 9815, KSC 9547 |
| | | EAC | Russia | IEC62493, IEC61547, EH55015 |
| | | RCM | Australia | EN55015, EN61000-3-2, EN61000-3-3, EN61547 |
| | | UKCA | Britain | BS EN IEC 55015, BS EN IEC 61000-3-2, BS EN 61000-3-3, BS EN 61547 |
| CUL | | Canada | ICES-005 | |
| UL | | America | FCC PART 15B | |
| EMC Immunity | EN61000-4-2,3,4,5,6,8,11, EN61547 | | | |
| ErP | Power Consumption | Networked standby | <0.5W (After shutdown by command) | |
| | | No-load power consumption | <0.5W (When the lamp is not connected) | |
| | Flicker/Stroboscopic Effect | IEEE 1789 | Meet IEEE 1789 standard/High frequency exemption level | |
| | | CIE SVM | Pst LM≤1.0, SVM≤0.4 | |
| OTHERS | Weight(N.W.) | 170g±10g | 150g±10g | |
| | Dimensions | 142×40×23mm(L×W×H) | | |

Product Size

Unit: mm

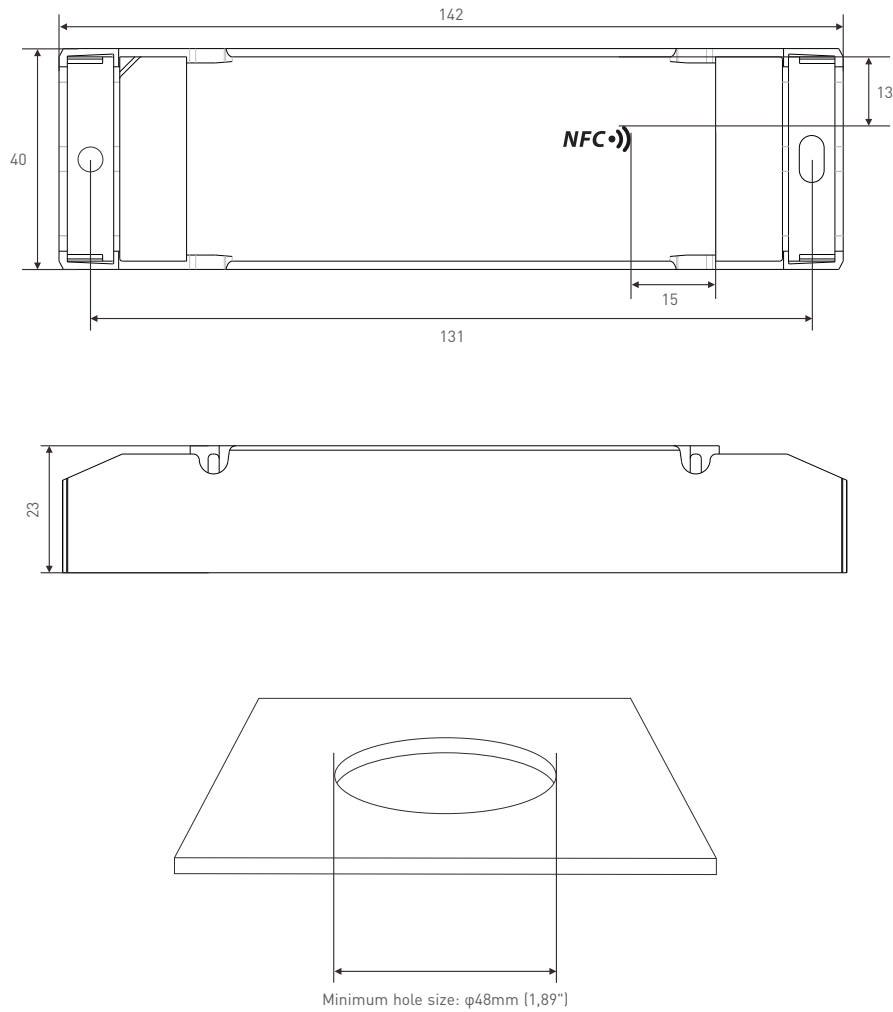

Wiring Diagram

0-10V Connection

1. Brightness adjustment

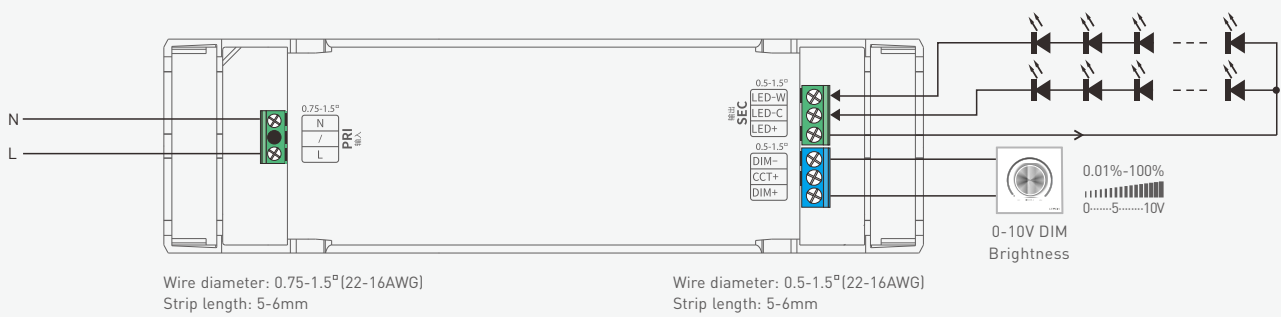

2. Color temperature adjustment

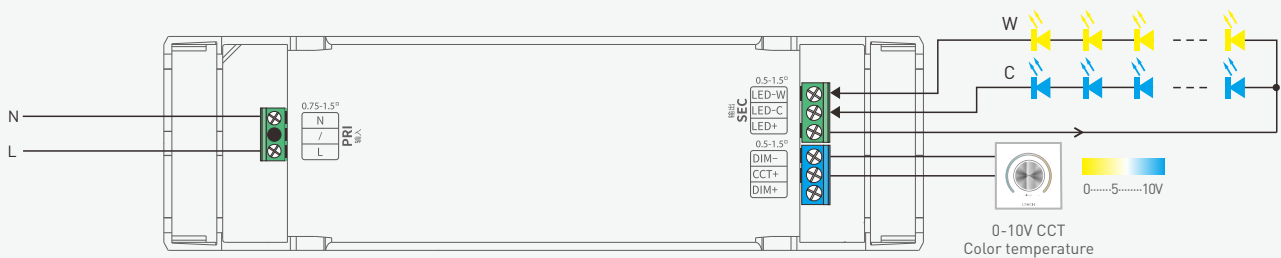

3. Brightness and color temperature adjustment respective

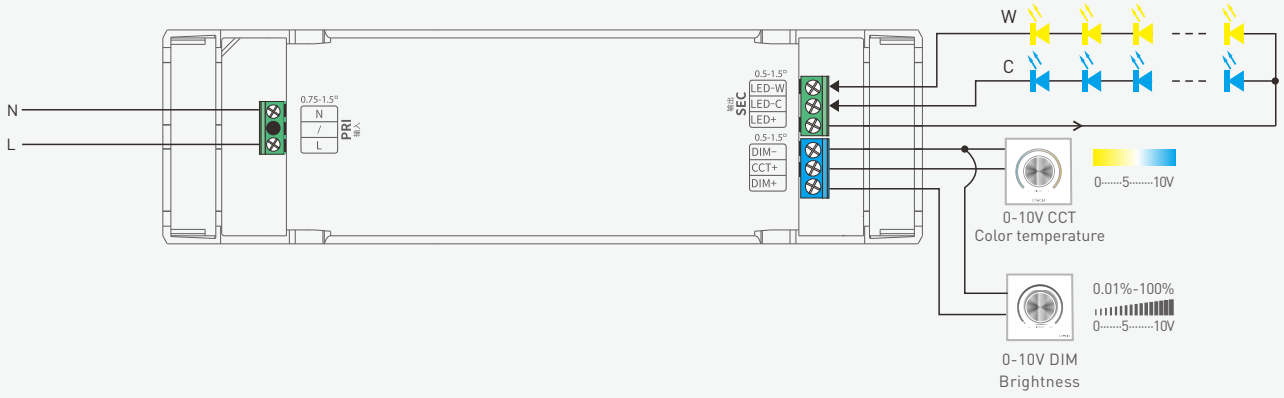

4. Brightness and color temperature adjustment simultaneous

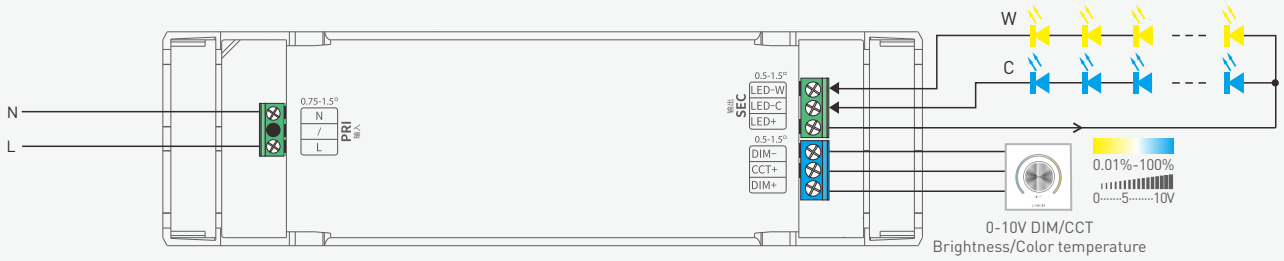

Four-wire LED connection

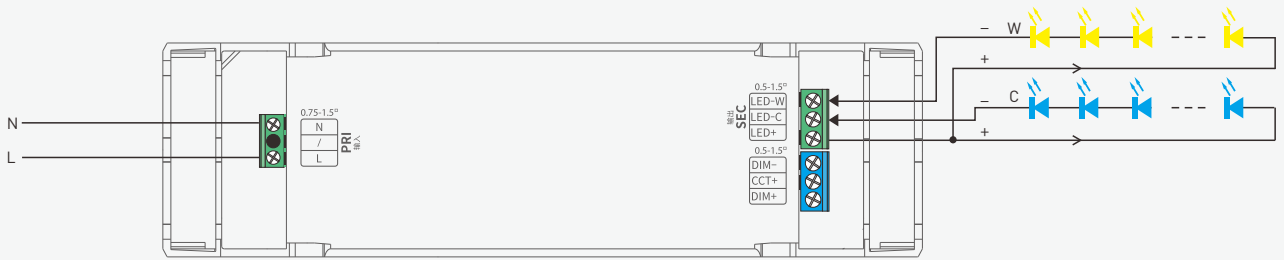

* Adopting constant power program design, it keeps the same brightness in color temperature dimming, twice the rated power load can be connected.
40W driver, 40W X 2CH load can be connected, the total power of the 2 channels will be kept in 40W.

Table of Typical Corresponding Parameters for Current

The typical 16 current data sets below are for reference when selecting LED fixture models. More current levels can be set by NFC using mobile APP with 300-1050mA adjustable in 1mA step

| SE-40-300-1050-W2A | Output Current | 300mA | 350mA | 400mA | 450mA | 500mA | 550mA | 600mA | 650mA | |
|--------------------|----------------|-----------|------------|-----------|------------|-----------|------------|-----------|------------|---------|
| | Output Voltage | 9-42Vdc | 9-42Vdc | 9-42Vdc | 9-42Vdc | 9-42Vdc | 9-42Vdc | 9-42Vdc | 9-42Vdc | 9-42Vdc |
| | Output Power | 2.7-12.6W | 3.15-14.7W | 3.6-16.8W | 4.05-18.9W | 4.5-21W | 4.95-23.1W | 5.4-25.2W | 5.85-27.3W | |
| | Output Current | 700mA | 750mA | 800mA | 850mA | 900mA | 950mA | 1000mA | 1050mA | |
| | Output Voltage | 9-42Vdc | 9-42Vdc | 9-42Vdc | 9-42Vdc | 9-42Vdc | 9-42Vdc | 9-40Vdc | 9-38Vdc | |
| | Output Power | 6.3-29.4W | 6.75-31.5W | 7.2-33.6W | 7.65-35.7W | 8.1-37.8W | 8.54-39.9W | 9-40W | 9.45-40W | |

The typical 13 current data sets below are for reference when selecting LED fixture models. More current levels can be set by NFC using mobile APP with 200-800mA adjustable in 1mA step

| SE-30-200-800-W2A | Output Current | 200mA | 250mA | 300mA | 350mA | 400mA | 450mA | 500mA | 550mA | |
|-------------------|----------------|-----------|------------|-----------|------------|-----------|------------|---------|------------|---------|
| | Output Voltage | 9-42Vdc | 9-42Vdc | 9-42Vdc | 9-42Vdc | 9-42Vdc | 9-42Vdc | 9-42Vdc | 9-42Vdc | 9-42Vdc |
| | Output Power | 1.8-8.4W | 2.25-10.5W | 2.7-12.6W | 3.15-14.7W | 3.6-16.8W | 4.05-18.9W | 4.5-21W | 4.95-23.1W | |
| | Output Current | 600mA | 650mA | 700mA | 750mA | 800mA | / | / | / | |
| | Output Voltage | 9-42Vdc | 9-42Vdc | 9-42Vdc | 9-40Vdc | 9-37.5Vdc | / | / | / | |
| | Output Power | 5.4-25.2W | 5.85-27.3W | 6.3-29.4W | 6.75-30W | 7.2-30W | / | / | / | |

Application Diagram of Protective Cover



1. Put the head of a screwdriver on the side of the housing to pry up both the protective cover and wire fixing board. Then remove the wire fixing board and connect to the wires as wiring diagram shows.

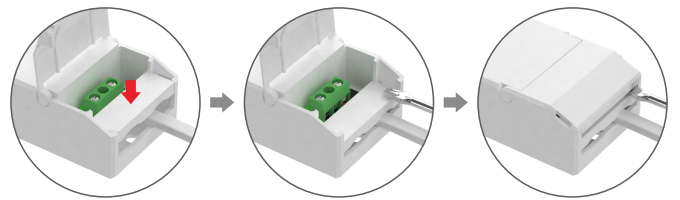

2. Install the wire fixing board and press it down. Then snap on the protective cover while pressing the wire fixing board with a small flat-head screwdriver

Installation Precautions

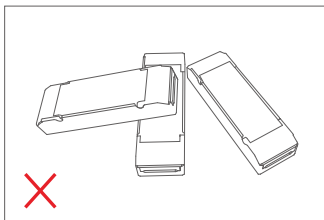

Please do not stack the products. The distance between two products should be $\geq 15\text{cm}$ so as not to affect heat dissipation or the lifetime of the products.

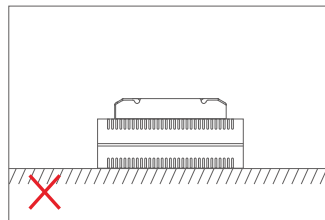
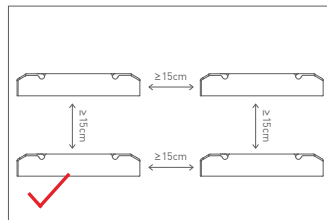

Please not place the products on power supplies. The distance between the product and the power supplies should be $\geq 15\text{cm}$ so as not to affect heat dissipation or shorten the lifetime of the products.

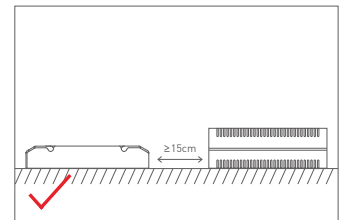

Note: The temperature within the installation area should be within the working temperature range of the products. Please do not install products inside LED fixtures to avoid temperature exceeding the working temperature that may affect the product lifetime.

Use the NFC Lighting APP

Scan the QR code below with your mobile phone and follow the prompts to complete the APP installation (According to performance requirements, you need to use a NFC-capable Android phone, or an iPhone 8 and later that are compatible with iOS 13 or higher).



* Before you begin setting the parameters of the driver, please make sure the driver is powered off.

Read/Write the LED driver

Use your NFC-capable phone to read LED driver data, then edit the parameters and they can be directly written to the driver.

1. Read the LED driver

On the APP home page, click **[Read/Write LED driver]**, then keep the programmer's sensing area close to the NFC logo of the driver to read the driver parameters.



2. Edit the parameters

Click **[Parameter settings]** to edit the advanced parameters, like output current, dimming mode, low power mode, etc.

3. Write to the driver

After completing the parameter settings, click **[Write]** in the upper right corner, and keep the programmer's sensing area close to the NFC logo of the driver, so the parameters can be written to the driver.

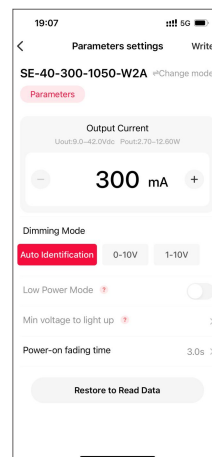
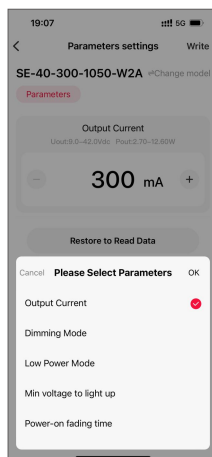
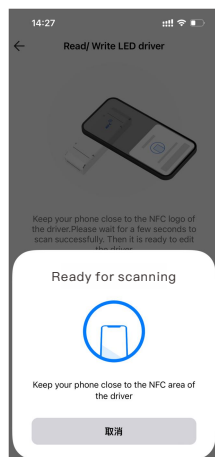
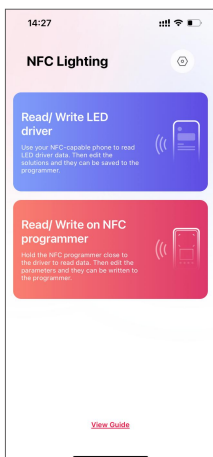

Relationship Diagrams

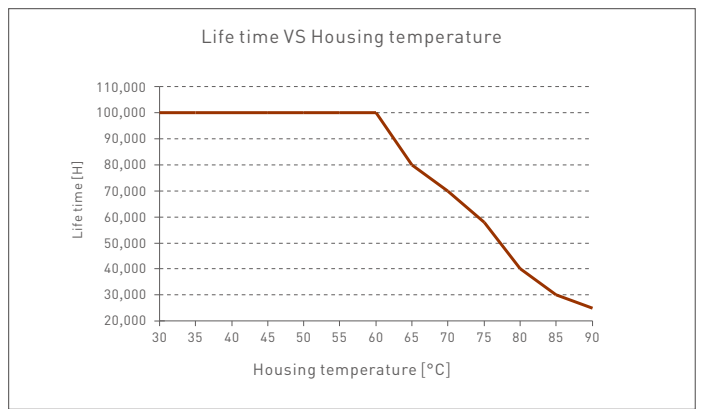
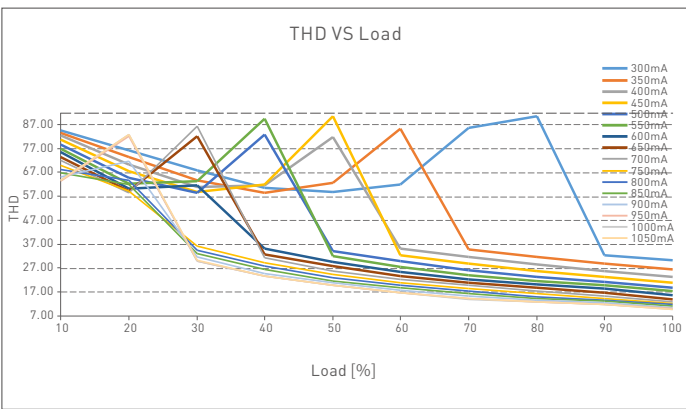
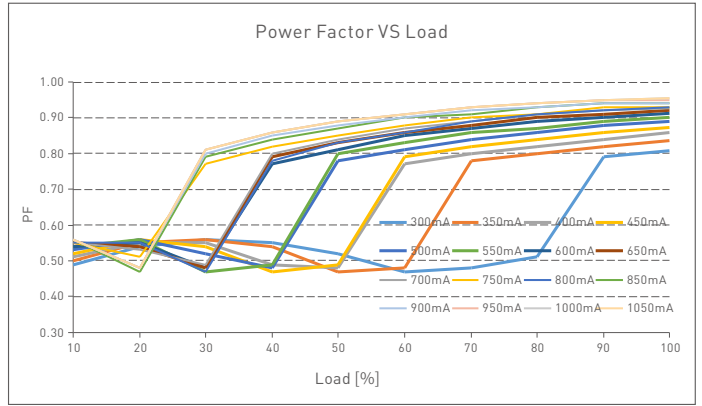
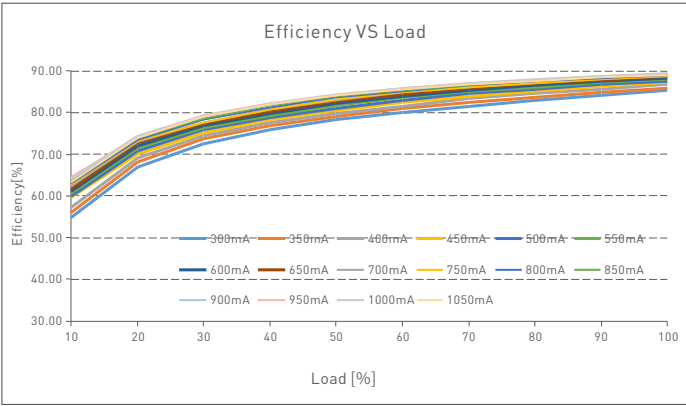

SE-40-300-1050-W2A

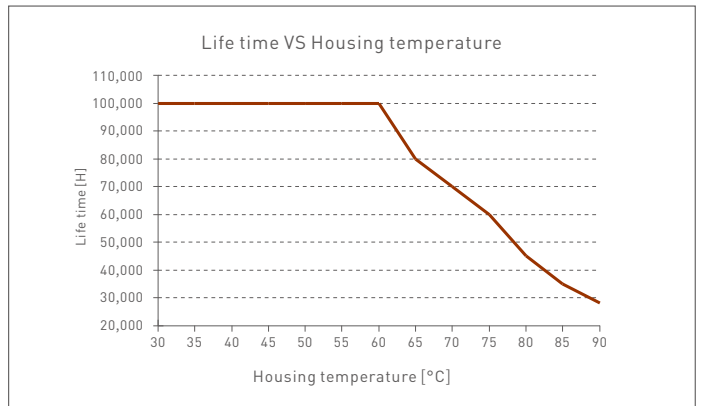
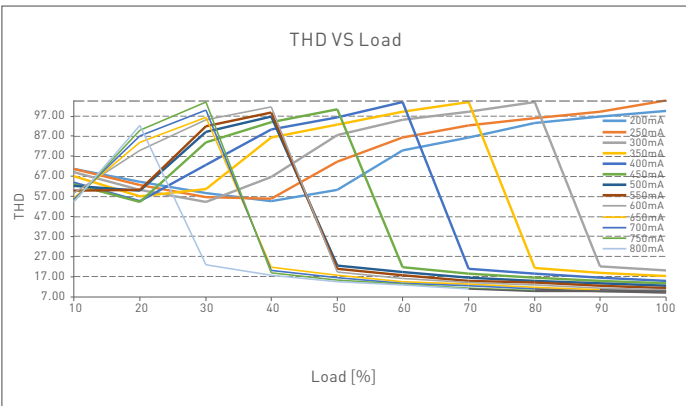
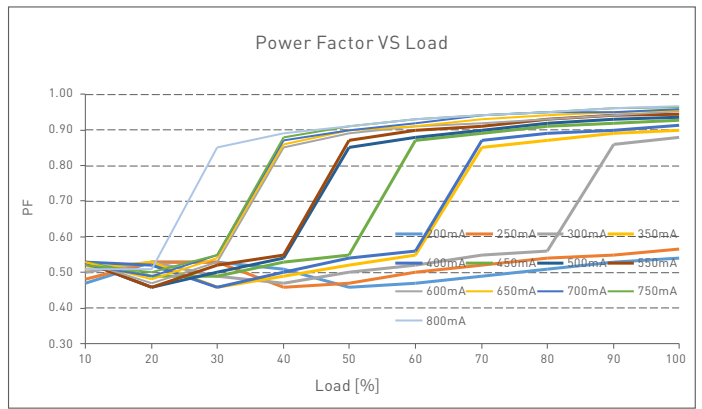
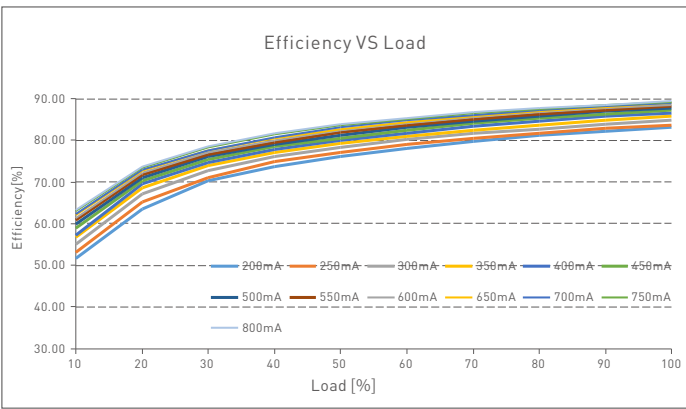

SE-30-200-800-W2A

Flicker Test Sheet

IEEE 1789

| Limit of modulation in low risk area | |
|---------------------------------------|---|
| Waveform frequency of optical output | limit (%) |
| $f \leq 8\text{Hz}$ | 0.2 |
| $8\text{Hz} < f \leq 90\text{Hz}$ | $0.025 \times f$ |
| $90\text{Hz} < f \leq 1250\text{Hz}$ | $0.08 \times f$ |
| $f > 1250\text{Hz}$ | Exemption assessment |
| Limit of modulation in no effect area | |
| Waveform frequency of optical output | limit (%) |
| $f \leq 10\text{Hz}$ | 0.1 |
| $10\text{Hz} < f \leq 90\text{Hz}$ | $0.01 \times f$ |
| $90\text{Hz} < f \leq 3125\text{Hz}$ | $[0.08/2.5] \times f$ |
| $f > 3125\text{Hz}$ | Exemption assessment (High frequency exemption) |

- Brightness
- ▲ 0.1%
 - ▲ 1%
 - ▲ 5%
 - ▲ 10%
 - 20%
 - ▲ 30%
 - 40%
 - ★ 50%
 - 60%
 - 70%
 - 80%
 - ★ 90%
 - ◆ 100%

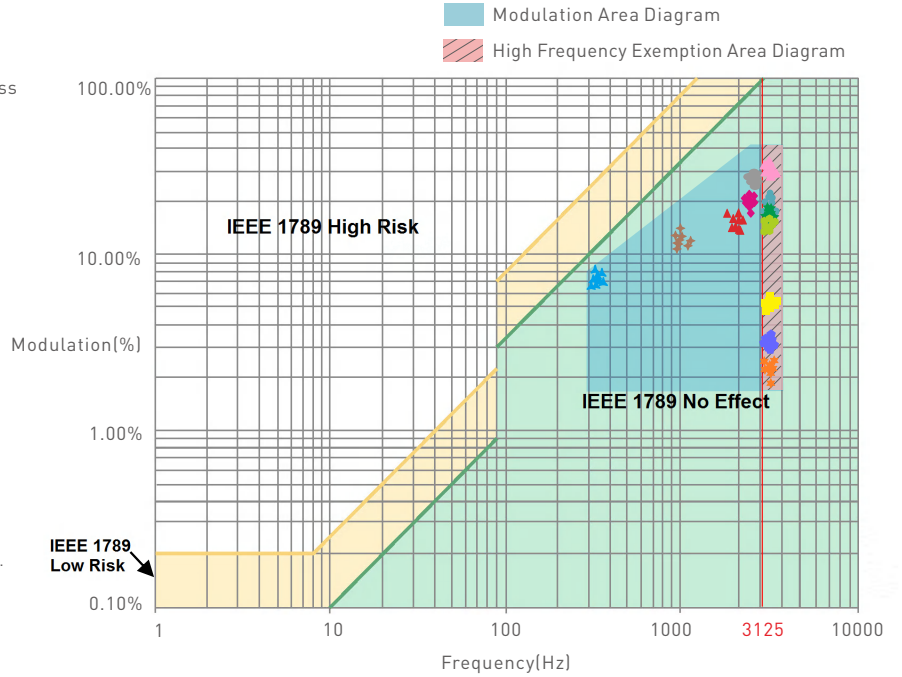

Marks in the right chart were tested results of different current ranges. The output frequency is 0Hz in 100% brightness and its corresponding modulation is 0%, which could not be shown in the right chart.

Packaging Specifications

| Model | SE-40-300-1050-W2A | SE-30-200-800-W2A |
|-------------------|--|--|
| Carton Dimensions | 320×275×106mm(L×W×H) | 320×275×106mm(L×W×H) |
| Quantity | 20 PCS/Layer; 2 Layers/Carton; 40 PCS/Carton | 20 PCS/Layer; 2 Layers/Carton; 40 PCS/Carton |
| Weight | 0.17 kg/PC; 7.6 kg±5%/Carton | 0.15 kg/PC; 6.8 kg±5%/Carton |

Packaging Image

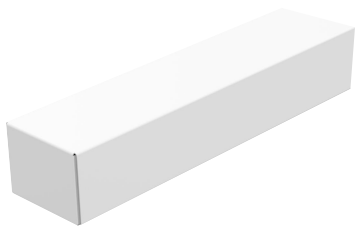

Inner Packaging Box



Carton Packaging

Transportation and Storage

1. Transportation

Products can be shipped via vehicles, boats and planes.

During transportation, products should be protected from rain and sun. Please avoid severe shock and vibration during the loading and unloading process.

2. Storage

The storage conditions should comply with the Class I Environmental Standards. The products that have been stored for more than six months are recommended to be re-inspected and can be used only after they have been qualified.

Attentions

- Products shall be installed by qualified professionals.
- LTECH products are and not lightningproof non-waterproof (special models excepted). Please avoid the sun and rain. When installed outdoors, please ensure they are mounted in a water proof enclosure or in an area equipped with lightning protection devices.
- Good heat dissipation will prolong the working life of products. Please ensure good ventilation.
- Please check if the working voltage used complies with the parameter requirements of products.
- The diameter of wire used must be able to load the light fixtures you connect and ensure the firm wiring.
- Before you power on products, please make sure all the wiring is correct in case of incorrect connection that causes damage to light fixtures.
- If a fault occurs, please do not attempt to fix products by yourself. If you have any question, please contact your suppliers.

* This manual is subject to changes without further notice. Product functions depend on the goods. Please feel free to contact our official distributors if you have any question.

Warranty Agreement

- Warranty periods from the date of delivery: 5 years.
- Free repair or replacement services for quality problems are provided within warranty periods.

Warranty exclusions below:

- Beyond warranty periods.
- Any artificial damage caused by high voltage, overload, or improper operations.
- Products with severe physical damage.
- Damage caused by natural disasters and force majeure.
- Warranty labels and barcodes have been damaged.
- No any contract signed by LTECH.

1. Repair or replacement provided is the only remedy for customers. LTECH is not liable for any incidental or consequential damage unless it is within the law.
2. LTECH has the right to amend or adjust the terms of this warranty, and release in written form shall prevail.

Update Log

| Version | Updated Time | Update Content | Updated by |
|---------|--------------|------------------|------------|
| A0 | 2023.02.23 | Original version | Liu Weili |